

Agilent TS-8989 PXI Functional Test System

Wiring Guide and Hardware Reference



Agilent Technologies

Notices

© Agilent Technologies Inc., 2014

No part of this manual may be reproduced in any form or by any means (including electronic storage and retrieval or translation into a foreign language) without prior agreement and written consent from Agilent Technologies Inc. as governed by United States and international copyright laws.

Manual Part Number

U8989-90001

Edition

First Edition, January 22, 2014

Printed in Malaysia

Agilent Technologies Microwave Products (Malaysia) Sdn. Bhd.

Bayan Lepas Free Industrial Zone
11900, Penang, Malaysia

Warranty

The material contained in this document is provided “as is,” and is subject to change, without notice, in future editions. Further, to the maximum extent permitted by the applicable law, Agilent disclaims all warranties, either express or implied, with regard to this manual and any information contained herein, including but not limited to the implied warranties of merchantability and fitness for a particular purpose. Agilent shall not be liable for errors or for incidental or consequential damages in connection with the furnishing, use, or performance of this document or of any information contained herein. Should Agilent and the user have a separate written agreement with warranty terms covering the material in this document that conflict with these terms, the warranty terms in the separate agreement shall control.

Technology Licenses

The hardware and/or software described in this document are furnished under a license and may be used or copied only in accordance with the terms of such license.

Restricted Rights Legend

U.S. Government Restricted Rights. Software and technical data rights granted to the federal government include only those rights customarily provided to end user customers. Agilent provides this customary commercial license in Software and technical data pursuant to FAR 12.211 (Technical Data) and 12.212 (Computer Software) and, for the Department of Defense, DFARS 252.227-7015 (Technical Data - Commercial Items) and DFARS 227.7202-3 (Rights in Commercial Computer Software or Computer Software Documentation).

Safety Notices

CAUTION

A **CAUTION** notice denotes a hazard. It calls attention to an operating procedure, practice, or the likes of that, if not correctly performed or adhered to, could result in damage to the product or loss of important data. Do not proceed beyond a **CAUTION** notice until the indicated conditions are fully understood and met.

WARNING

A **WARNING** notice denotes a hazard. It calls attention to an operating procedure, practice, or the likes of that, if not correctly performed or adhered to, could result in personal injury or death. Do not proceed beyond a **WARNING** notice until the indicated conditions are fully understood and met.

Table of Contents

1 Legal Information

Warranty	2
Technology Licenses	2
Restricted Rights Legend	3
Service and Support	4
Agilent on the web	4
Agilent by phone	4

2 Safety and Regulatory Information

Safety Summary	6
Safety Notices	6
General Safety Considerations	7
Environmental Conditions	8
Before Applying Power	9
Ground the System	9
Fuses	9
Operator Safety Information	10
Safety Symbols and Regulatory Markings	11
Declaration of Conformity	13
Electrostatic Discharge (ESD) Precautions	14
End of Life: Waste Electrical and Electronic Equipment (WEEE) Directive 2002/96/EC	15

3 System Overview

System Intended Use	18
---------------------	----

Instructions For Use	19
Test System Specifications and Capabilities	20
Test Capabilities – Measurement Sample Methods	22
TS-8989 System Overview	25
U8989-66601 Universal Instrument Routing Card	27
U8989-66602 Breakout IO Card	29
Instrumentation (PXI/PCI) Subsystem	30
PXI/PCI modules pinout	31
Switch/Load Unit (SLU) Subsystem	41
Switch/Load Unit pinout	42

4 System Interconnects

System Interface	52
Mounting Plate Installation	54

5 Test System Interface Cables

U8989-61606 DAC M9185A to Instrument Routing Card or E8792A Pin Matrix Aux Cable	58
U8989-61609 DIO M9187A to Instrument Routing Card Cable	60
U8989-61607 DAQ M9216A to Instrument Routing Card Cable	62
U8989-61608 DAQ M9216A Aux to E8792A Pin Matrix Aux Cable	64
U8970-61705 DAQ M9216A Aux to E8782A Pin Matrix Aux Cable	66
U8989-61611 VI M9186A to Instrument Routing Card and Pin Matrix Instrument Cable	69
U8989-61610 PCI DIO AD1750 Cable	71
U8989-61612 PCI Softing CAN (CAN-AC2-PCI) Cable	73

List of Figures

Figure 2-1	Examples of exposed connectors	10
Figure 3-1	E8782A Instrument Matrix Card block diagram	23
Figure 3-2	TS-8989 System Overview (Instrument Interface)	25
Figure 3-3	TS-8989 System Overview (DUT Interface)	26
Figure 3-4	U8989-66601 Universal Instrument Routing Card	27
Figure 3-5	U8989-66602 Breakout IO Card	29
Figure 3-6	PXI M9185A DAC Pinout (With DAC 16 Channel)	32
Figure 3-7	PXI M9185A DAC Pinout (With DAC 8 Channel)	33
Figure 3-8	PXI M9186A VI Pinout	34
Figure 3-9	PXI M9187A DIO Pinout	35
Figure 3-10	PXI M9216A DAQ Input Port Pinout	36
Figure 3-11	PXI M9216A DAQ Aux Port Pinout (E879xA)	37
Figure 3-12	PXI M9216A DAQ Aux Port Pinout (E878xA)	38
Figure 3-13	PCI AD1750 DIO Pinout	39
Figure 3-14	PCI Softing CAN Pinout	40
Figure 3-15	E8792A/E8793A 32-pin Matrix Card Pinout	42
Figure 3-16	E8782A/E8783A 64-pin Matrix Card Pinout	43
Figure 3-17	78-pin SLU System Utility Pinout	44
Figure 3-18	N9379A 48 Channel Load Card Pinout	45
Figure 3-19	E6176A/N9377A/U7179A 16 Channel Load Card Pinout	46
Figure 3-20	E6177A/U7177A/N9378A 24 Channel Load Card Pinout	47
Figure 3-21	E6175A 8 Channel Load Card Pinout	48
Figure 3-22	E6178B/U7178A 8 Channel Heavy Duty Load Card Pinout	49
Figure 4-1	E6170-02100 Mounting Plate	53
Figure 4-2	Mounting Plate Installation Step 1	54
Figure 4-3	Mounting Plate Installation Step 2	54
Figure 4-4	Mounting Plate Installation Step 3	55
Figure 4-5	Mounting Plate Installation Step 4	56
Figure 4-6	Mounting Plate Installation Step 5	56
Figure 5-1	U8989-61606 DAC M9185A to Instrument Routing Card or E8792A Pin Matrix Aux Cable	58
Figure 5-2	U8989-61609 DIO M9187A to Instrument Routing Card	

- Cable [60](#)
- Figure 5-3** U8989-61607 DAQ M9216A to Instrument Routing Card Cable [62](#)
- Figure 5-4** U8989-61608 DAQ M9216A Aux to E8792A Pin Matrix Aux Cable [64](#)
- Figure 5-5** U8970-61705 DAQ M9216A Aux to E8782A Pin Matrix Aux Cable [66](#)
- Figure 5-6** U8989-61611 VI M9186A to Instrument Routing Card and Pin Matrix Instrument Cable [69](#)
- Figure 5-7** U8989-61610 PCI DIO AD1750 Cable [71](#)
- Figure 5-8** U8989-61612 PCI Softing CAN (CAN-AC2-PCI) Cable [73](#)

List of Tables

Table 2-1	General environmental requirements	8
Table 2-2	Safety symbols and regulatory markings	11
Table 2-3	Suggested anti-static solutions for site planning	14
Table 3-1	Typical TS-8989 instrumentation	20
Table 3-2	U8989-66601 Cable Pinout	28
Table 4-1	Available modules and connector types	52
Table 5-1	U8989-61606 Cable Pinout	59
Table 5-2	U8989-61609 Cable Pinout	61
Table 5-3	U8989-61607 Cable Pinout	63
Table 5-4	U8989-61608 Cable Pinout	65
Table 5-5	U8970-61705 Cable Pinout	67
Table 5-6	U8970-61705 Cable Pinout	68
Table 5-7	U8989-61611 Cable Pinout	70
Table 5-8	U8989-61610 Cable Pinout	72
Table 5-9	U8989-61612 Cable Pinout	74

THIS PAGE HAS BEEN INTENTIONALLY LEFT BLANK.

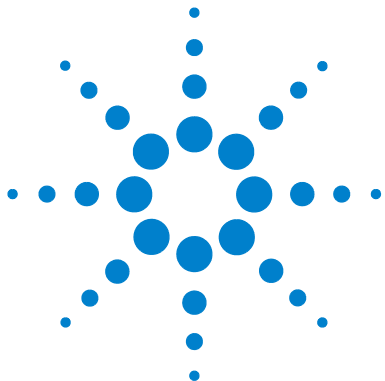

1 Legal Information

Warranty	2
Technology Licenses	2
Restricted Rights Legend	3
Service and Support	4
Agilent on the web	4
Agilent by phone	4



Warranty

The material contained in this document is provided “as is,” and is subject to being changed, without notice, in future editions.

Further, to the maximum extent permitted by applicable law, Agilent disclaims all warranties, either express or implied, with regard to this manual and any information contained herein, including but not limited to the implied warranties of merchantability and fitness for a particular purpose.

Agilent shall not be liable for errors or for incidental or consequential damages in connection with the furnishing, use, or performance of this document or of any information contained herein.

Should Agilent and the user have a separate written agreement with warranty terms covering the material in this document that conflict with these terms, the warranty terms in the separate agreement shall control.

Technology Licenses

The hardware and/or software described in this document are furnished under a license and may be used or copied only in accordance with the terms of such license.

Restricted Rights Legend

If software is for use in the performance of a U.S. Government prime contract or subcontract, Software is delivered and licensed as “Commercial computer software” as defined in DFAR 252.227-7014 (June 1995), or as a “commercial item” as defined in FAR 2.101(a) or as “Restricted computer software” as defined in FAR 52.227-19 (June 1987) or any equivalent agency regulation or contract clause. Use, duplication, or disclosure of Software is subject to Agilent Technologies’ standard commercial license terms, and non-DOD Departments and Agencies of the U.S. Government will receive no greater than Restricted Rights as defined in FAR 52.227-19(c)(1-2)(June 1987). U.S. Government users will receive no greater than Limited Rights as defined in FAR 52.227-14 (June 1987) or DFAR 252.227-7015 (b)(2)(November 1995), as applicable in any technical data.

Service and Support

Any adjustment, maintenance, or repair of this product must be performed by qualified personnel. Contact your customer engineer through your local Agilent Service Center.

Agilent on the web

You can find information about technical and professional services, product support, and equipment repair and service on the web: <http://www.agilent.com/>

Double-click the link to **Test & Measurement**. Select your country from the drop-down menus. The web page that appears next has contact information specific for your country.

Agilent by phone

If you do not have access to the Internet, call one of the numbers in the “[Contact us](#)” section at the end of this manual.



2 Safety and Regulatory Information

Safety Summary	6
Safety Notices	6
General Safety Considerations	7
Environmental Conditions	8
Before Applying Power	9
Ground the System	9
Fuses	9
Operator Safety Information	10
Safety Symbols and Regulatory Markings	11
Declaration of Conformity	13
Electrostatic Discharge (ESD) Precautions	14
End of Life: Waste Electrical and Electronic Equipment (WEEE) Directive 2002/96/EC	15



Safety Summary

The following general safety precautions must be observed during all phases of operation of this instrument. Failure to comply with these precautions or with specific warnings elsewhere in this manual violates safety standards of design, manufacture, and intended use of the instrument. Agilent Technologies, Inc. assumes no liability for the customer's failure to comply with these requirements.

Safety Notices

CAUTION

A CAUTION notice denotes a hazard. It calls attention to an operating procedure, practice, or the like, that, if not correctly performed or adhered to, could result in damage to the product or loss of important data. Do not proceed beyond a CAUTION notice until the indicated conditions are fully understood and met.

WARNING

A WARNING notice denotes a hazard. It calls attention to an operating procedure, practice, or the like that, if not correctly performed or adhered to, could result in personal injury or death. Do not proceed beyond a WARNING notice until the indicated conditions are fully understood and met.

General Safety Considerations

This product is provided with a protective earth terminal. The protective features of this product may be impaired if it is used in a manner not specified in the operation instructions.

WARNING

- **DO NOT OPERATE IN AN EXPLOSIVE ATMOSPHERE. Do not operate the product in the presence of flammable gases or flames.**
 - **DO NOT REMOVE RACK PANELS OR INSTRUMENT COVERS. Operating personnel must not remove any rack panels or instrument covers. Component replacement and internal adjustments must be made only by qualified service personnel. Products that appear damaged or defective should be made inoperative and secured against unintended operation until they can be repaired by a qualified service personnel.**
 - **The protection provided by the TS-8989 system may be impaired if the system is used in a manner not specified by Agilent.**
-

Environmental Conditions

The TS-8989 Automotive Electronics PXI Functional Test System is designed for indoor use only. [Table 2-1](#) shows the general environmental requirements.

Table 2-1 General environmental requirements

Environment condition	Requirement
Maximum altitude	2000 meters
Operating temperature	5 °C to 40 °C
Relative humidity	The test system is designed to operate in the range from 5% to 80% relative humidity (non-condensing)

CAUTION

This product is designed for use in Installation Category II and Pollution Degree 2, per IEC 61010-1 and 664 respectively.

Before Applying Power

Verify that the product is set to match the available line voltage and that all safety precautions are taken. Note the external markings of the instruments described in [“Safety Symbols and Regulatory Markings”](#).

Ground the System

Agilent chassis' are provided with a grounding-type power plug. The instrument chassis and cover must be connected to an electrical ground to minimize shock hazard. The ground pin must be firmly connected to an electrical ground (safety ground) terminal at the power outlet. Any interruption of the protective (grounding) conductor or disconnection of the protective earth terminal will cause a potential shock hazard that could result in personal injury.

Fuses

Use only fuses with the required rated current, voltage, and specified type (fast acting). Do not use repaired fuses or short-circuited fuse holders. Doing so could cause a shock or fire hazard.

WARNING

To avoid electrical hazards, all system internal fuses must be replaced by trained and qualified personnel.

Operator Safety Information

WARNING

Module connectors and test signal cables connected to them cannot be operator-accessible.

Cables and connectors are considered inaccessible if a tool (such as a screwdriver, wrench, or socket) or a key (for equipment in a locked cabinet) is required to gain access to a conductive surface connected to any cable conductor (High, Low, or Guard).

WARNING

Do not touch the exposed connector pins or remove connected cables while the system is powered ON (see [Figure 2-1](#)).









Figure 2-1 Examples of exposed connectors



Safety Symbols and Regulatory Markings

Symbols and markings on the system, in manuals, and on instruments alert you to potential risks, provide information about conditions, and comply with international regulations. [Table 2-2](#) defines the symbols and markings you may find in a manual or on an instrument.









Table 2-2 Safety symbols and regulatory markings

Symbol	Description
Safety symbol	
	Warning: risk of electrical shock.
	Warning: hot surface.
	Caution: refer to accompanying documents.
	Laser radiation symbol: marked on products that have a laser output.
	Alternating current.
	Both direct and alternating current.
	3-phase alternating current.
	Earth (ground) terminal.
	Protective earth (ground) terminal.

2 Safety and Regulatory Information

Safety Symbols and Regulatory Markings

Table 2-2 Safety symbols and regulatory markings (continued)

Symbol	Description
	Frame or chassis terminal.
	Terminal is at earth potential. Used for measurement and control circuits designed to be operated with one terminal at earth potential.
	Terminal for a neutral conductor on permanently installed equipment.
	Terminal for a line conductor on permanently installed equipment.
	Standby (supply); units with this symbol are not completely disconnected from the AC mains when this switch is turned off. To completely disconnect the unit from the AC mains, either disconnect the power cord, or have a qualified electrician install an external switch.
Regulatory marking	
	The CE mark is a registered trademark of the European Community. If it is accompanied by a year, it indicates the year the design was proven.
	The CSA mark is a registered trademark of the Canadian Standards Association.
	The C-tick mark is a registered trademark of the Spectrum Management Agency of Australia. This signifies compliance with the Australian EMC Framework regulations under the terms of the Radio Communications Act of 1992.
ISM - 1A	This text indicates that the instrument is an Industrial Scientific and Medical Group 1 Class A product (CISPER 11, Clause 4).

Declaration of Conformity

The Declaration of Conformity (DoC) for this instrument is available on the Agilent website. You can search the DoC by its product model or description at the web address below.

<http://regulations.corporate.agilent.com/DoC/search.htm>

NOTE

If you are unable to search for the respective DoC, contact your local Agilent representative.

Electrostatic Discharge (ESD) Precautions

Static electricity is destructive to your production process and the TS-8989. Careless handling and poor site planning can cause system reliability problems and reduce your product yield. The system may not be as easily damaged as the modules you will be testing, but good anti-static planning will help ensure high reliability.

The ESD symbol below indicates areas where ESD caution must be exercised. This is to prevent damage to instruments and/or test disruption.



Caution: static sensitive

Electrostatic discharge in this area may cause equipment damage and/or test disruption.

While not an exhaustive list of anti-static precautions, [Table 2-3](#) provides suggestions to consider as you plan your system area.

Table 2-3 Suggested anti-static solutions for site planning

Precaution	Suggested solution
Anti-static flooring	Plan to use an anti-static floor covering or mats.
Grounding straps	Plan for foot straps in conjunction with anti-static flooring and wrist straps for system operators.

End of Life: Waste Electrical and Electronic Equipment (WEEE) Directive 2002/96/EC

This instrument complies with the WEEE Directive (2002/96/EC) marking requirement. This affixed product label indicates that you must not discard this electrical or electronic product in domestic household waste.

Product Category:

With reference to the equipment types in the WEEE directive Annex 1, this instrument is classified as a “Monitoring and Control Instrument” product.

The affixed product label is as shown below.



Do not dispose in domestic household waste.

To return this unwanted instrument, contact your nearest Agilent Service Center, or visit

www.agilent.com/environment/product

for more information.

2 Safety and Regulatory Information

End of Life: Waste Electrical and Electronic Equipment (WEEE) Directive 2002/96/EC

THIS PAGE HAS BEEN INTENTIONALLY LEFT BLANK.



3 System Overview

System Intended Use	18
Instructions For Use	19
Test System Specifications and Capabilities	20
Test Capabilities – Measurement Sample Methods	22
TS-8989 System Overview	25
U8989-66601 Universal Instrument Routing Card	27
U8989-66602 Breakout IO Card	29
Instrumentation (PXI/PCI) Subsystem	30
PXI/PCI modules pinout	31
Switch/Load Unit (SLU) Subsystem	41
Switch/Load Unit pinout	42



System Intended Use

The Agilent TS-8989 PXI functional test system is a very lean and cost effective solution designed to be used in mechatronic test environments. The core of the TS-8989 is the Switch/Load Unit with an 8-slots PXI chassis integrated within and 11-slots for Switch/Load Unit cards. The main value differentiator for the TS-8989 is its size, and its ability to handle loads >5 A (up to 40 A), which is typical required for automotive applications.

Instructions For Use

The Agilent TS-8989 system contain all of the instrumentation needed to test most electronics modules. You may also add additional instruments and cabling to increase the test capabilities of the system. The locations of the instruments are standardized as much as possible. Because the Agilent TS-8989 system uses open system standards and is configurable by the system integrator, systems at your site may be different from the factory configurations.

Typical system operation is dependent on the target application. The system is to be modified by trained personnel for the target test module application. Typically, the test system development process consists of:

- Identifying the number of load resources required and assigning the load resources
- Identifying the number of measurement resources required and assigning the measurement resources
- Identifying the ECM serial interface communication needs and assigning the serial resources
- Identifying the fixture control resources required and assigning the I/O and power resources
- Constructing the test fixture and the test system interconnect cabling required for the specific application
- Developing the TXSL based test-plan for the specific application
- Developing the software operator user interface for the specific application
- Validating and deploying the test system to the manufacturing site

Test System Specifications and Capabilities

The TS-8989 PXI functional test system specifications are derived directly from the specifications of the instrumentation that make up the system.

The overall test system measurement capability is a combination of the measurement uncertainty as specified by the individual instrumentation combined with the system switch paths of the switching sub-systems. For test system instrumentation specifications and characteristics, refer directly to the manufacturer documentation.

Table 3-1 lists various instrumentations that may be configured into the system. Refer to the manufacturer supplied datasheets for detailed specifications.

Table 3-1 Typical TS-8989 instrumentation

Part number	Manufacturer	Description
E6198B	Agilent Technologies	21 Slot Switch/Load Unit
E8782A	Agilent Technologies	40 Channel Measurement and 24 Channel Instrument Matrix Card
E8783A	Agilent Technologies	64-pin Matrix Card
E8792A	Agilent Technologies	32 Channel Measurement and 16 Channel Instrument Matrix Card
E8793A	Agilent Technologies	32-pin Matrix Card
E6175A	Agilent Technologies	8 Channel Load Card
E6176A	Agilent Technologies	16 Channel Load Card
E6177A	Agilent Technologies	24 Channel Load Card
E6178B	Agilent Technologies	8 Channel Load Card
U7177A	Agilent Technologies	24 Channel Load Card with Current Sense
U7178A	Agilent Technologies	8 Channel Heavy Duty Load Card
U7179A	Agilent Technologies	16 Channel High Current Load Card

Table 3-1 Typical TS-8989 instrumentation (continued)

Part number	Manufacturer	Description
N9377A	Agilent Technologies	16 Channel Dual-Load Load Card
N9378A	Agilent Technologies	24 Channel Low Resistance Load Card
N9379A	Agilent Technologies	48 Channel High Density Load Card
M9182A	Agilent Technologies	DMM
M9183A	Agilent Technologies	DMM
M9186A	Agilent Technologies	V/I Source
M9185A	Agilent Technologies	8 Channel/16 Channel DAC
M9216A	Agilent Technologies	32 Channel HV-DAQ
M9187A	Agilent Technologies	32 Channel Digital I/O
PCI-1750	Advantech Corporation	32 Channel Isolated Digital I/O
PXI-3980	ADLINK Technology	PXI Embedded Controller
PXI-8565	ADLINK Technology	PCI Express-to-PXI Expansion Interface Card for PXI Chassis
PCIe-8560	ADLINK Technology	PCI Express-to-PXI Expansion Interface Card for Host PC

Test Capabilities – Measurement Sample Methods

The following steps serve as a guideline to determine if the Agilent TS-8989 Test System is able to meet your Electronic Control Module (ECM) test requirements.

Determine the accuracy required to test the ECM. For example, a particular output driver test measurement requires a measurement of $12.5\text{ V} \pm 10\text{ mV}$.

- 1 Retrieve the instrument's specifications from the datasheet or manual, for example, the Agilent M9183 accuracy specification for 20 V range:

The 1-year accuracy specifications \pm (% of reading + % of range) of the Agilent M9183A PXI DMM for DC voltage in 20 V range is 0.0070% of reading + 0.0008% of range at $23\text{ }^{\circ}\text{C} \pm 5\text{ }^{\circ}\text{C}$.

M9183A @ 20 V range = 0.0070% of reading + 0.0008% of range = $0.875\text{ mV} + 0.16\text{ mV} = \mathbf{1.035\text{ mV}}$

- 2 Determine the path, including the number of relays, from DMM to DUT. From this, determine the accuracy offset incurred by all the relays.

The typical thermal offset of a reed relay used in the pin matrix card should not exceed $50\text{ }\mu\text{V}$.

Figure 3-1 shows the block diagram for the E8782A Instrument Matrix Card. When making a DCV measurement, depending on the application, there will be either 6 or 8 reed relays involved. Reed relays marked 7 and 8 in the figure are used if there is a need to bypass the $200\text{ }\Omega$ protection resistors on the ABus.

Figure 3-1 E8782A Instrument Matrix Card block diagram

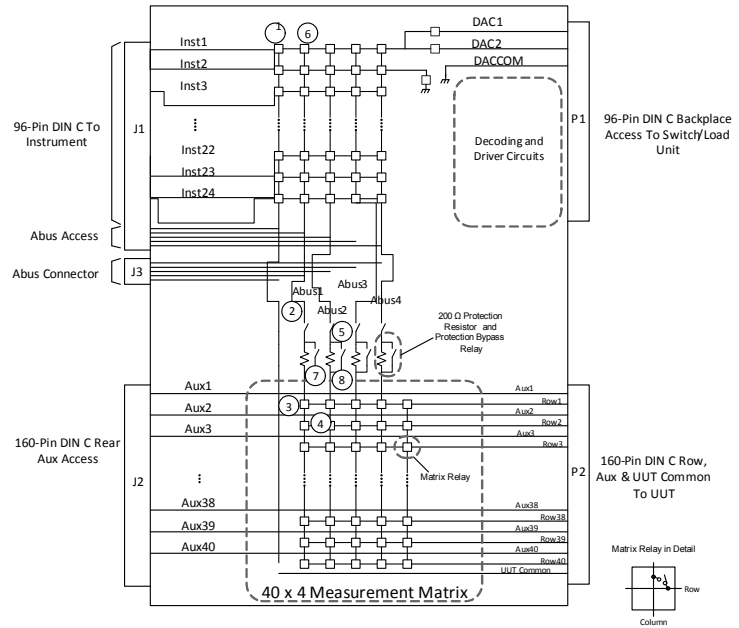

3 Determine the thermal offset from any other sources, for example, contact between the banana plug and the DMM input ports.

The typical thermal offset between the banana plug and the DMM input ports should not exceed 15 μV .

The calculated system error due to the thermal offsets using the Root Sum Square (RSS) method (banana plug and reed relays)

$$= \sqrt{(15 \mu\text{V})^2 + 8 \cdot (50 \mu\text{V})^2}$$

$$= \mathbf{142.2 \mu\text{V}}$$

3 System Overview

Test Capabilities – Measurement Sample Methods

- 4 Calculate the sum of the accuracy uncertainty due to the instrument's specifications and system switch paths, and compare it to the accuracy required by the DUT.

The calculated system accuracy offset using the Root Sum Square (RSS) method (DMM accuracy offset and thermal offset)

$$= \sqrt{(1.035 \text{ mV})^2 + (142.2 \text{ } \mu\text{V})^2}$$

$$= \mathbf{1.04 \text{ mV}}$$

The measurement accuracy for 12.5 V in percentage

$$= (1.04 \text{ mV} / 12.5 \text{ V}) * 100\%$$

$$= \mathbf{0.008\%}$$

The calculated TS-8989 System Capability Accuracy for a 12.5 V reading is 0.008%. This value may vary depending on application, temperature, and hardware accuracy.

TS-8989 System Overview

Figure 3-2 TS-8989 System Overview (Instrument Interface)

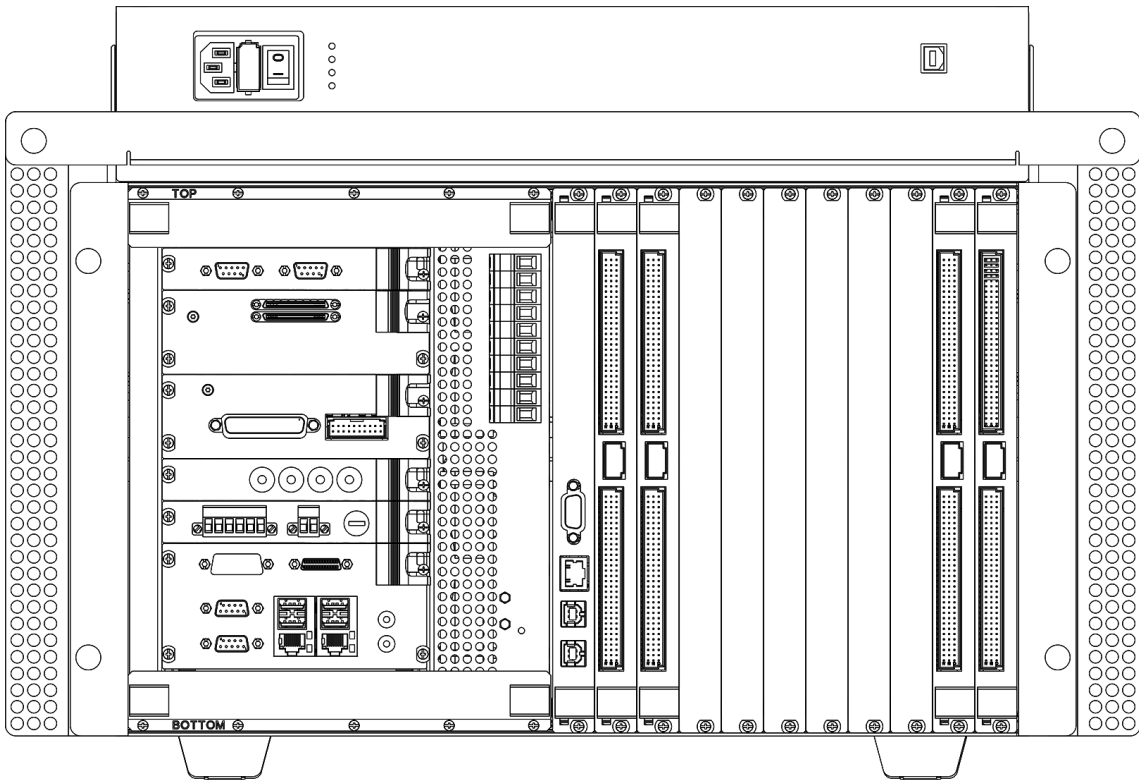

3 System Overview

TS-8989 System Overview

Figure 3-3 TS-8989 System Overview (DUT Interface)

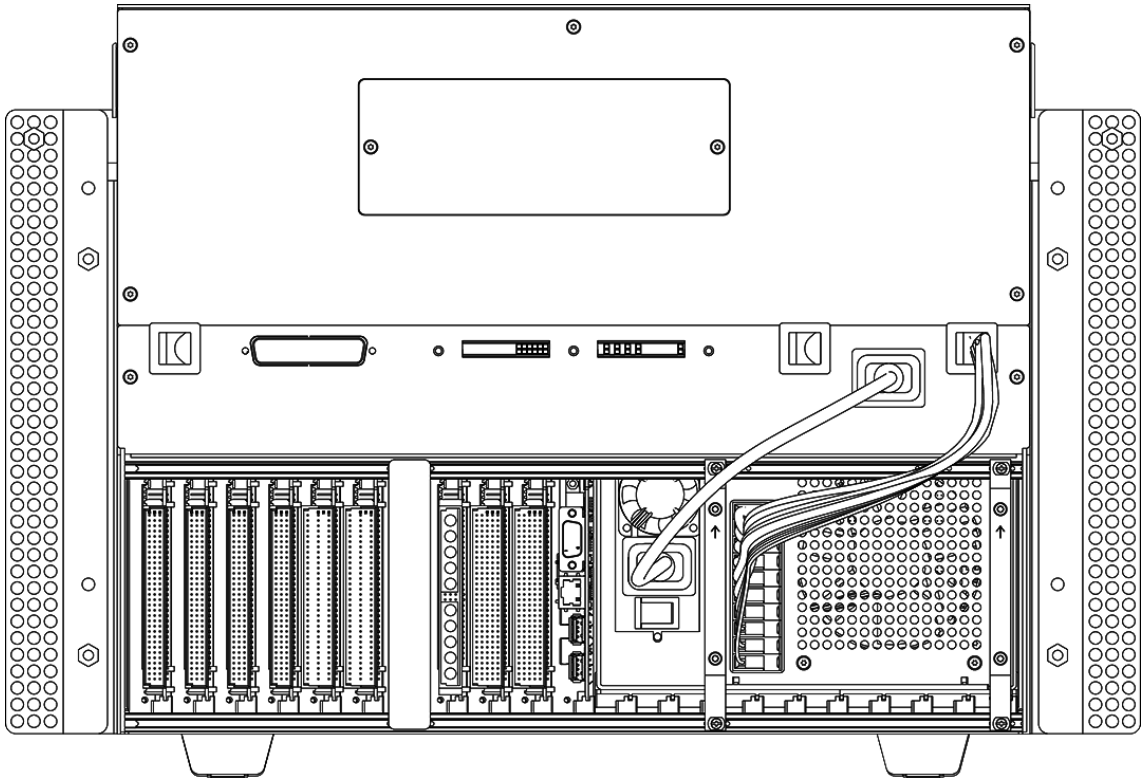

U8989-66601 Universal Instrument Routing Card

The U8989-66601 universal instrument routing card is designed to connect the PXI and PCI modules from the instrument interface to the DUT interface. This card has five connectors which are P1 and P2; and J1, J2, and J3 respectively. P1 is connected to the SLU backplane^[1] and P2's connectivity is directly from connectors J1, J2, and J3. Table 3-2 shows the card pinout.

Figure 3-4 U8989-66601 Universal Instrument Routing Card

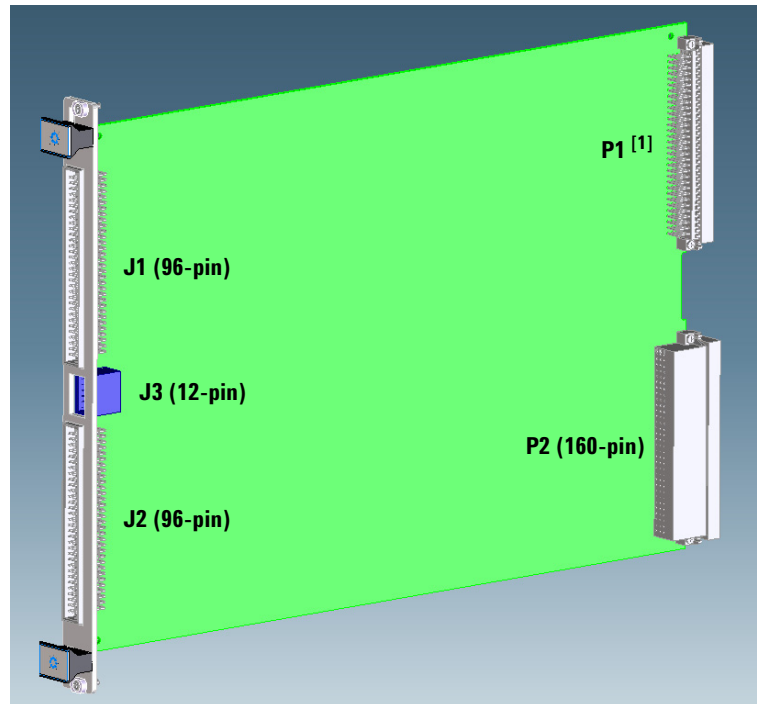

[1] There is no connectivity between the P1 connector to the SLU backplane. The connector serves as a guide and secures the universal instrument routing card on the SLU rail.

3 System Overview

U8989-66601 Universal Instrument Routing Card

Table 3-2 U8989-66601 Cable Pinout

On J1 Connector				On J3 Connector			On J2 Connector				On P3 Connector					
Row	a	b	c	Row	a	b	Row	a	b	c	Row	e	d	c	b	a
32	COM1	J1_33	J1_1	6	J3_1	J3_7	32	COM2	J2_33	J2_1	1	J1_1	J1_33	COM1	J2_33	J2_1
31	COM1	J1_34	J1_2	5	J3_2	J3_8	31	COM2	J2_34	J2_2	2	J1_2	J1_34	COM1	J2_34	J2_2
30	COM1	J1_35	J1_3	4	J3_3	J3_9	30	COM2	J2_35	J2_3	3	J1_3	J1_35	COM1	J2_35	J2_3
29	COM1	J1_36	J1_4	3	J3_4	J3_10	29	COM2	J2_36	J2_4	4	J1_4	J1_36	COM1	J2_36	J2_4
28	COM1	J1_37	J1_5	2	J3_5	J3_11	28	COM2	J2_37	J2_5	5	J1_5	J1_37	COM1	J2_37	J2_5
27	COM1	J1_38	J1_6	1	J3_6	J3_12	27	COM2	J2_38	J2_6	6	J1_6	J1_38	COM1	J2_38	J2_6
26	COM1	J1_39	J1_7				26	COM2	J2_39	J2_7	7	J1_7	J1_39	COM1	J2_39	J2_7
25	COM1	J1_40	J1_8				25	COM2	J2_40	J2_8	8	J1_8	J1_40	COM1	J2_40	J2_8
24	COM1	J1_41	J1_9				24	COM2	J2_41	J2_9	9	J1_9	J1_41	COM1	J2_41	J2_9
23	COM1	J1_42	J1_10				23	COM2	J2_42	J2_10	10	J1_10	J1_42	COM1	J2_42	J2_10
22	COM1	J1_43	J1_11				22	COM2	J2_43	J2_11	11	J1_11	J1_43	J3_1	J2_43	J2_11
21	COM1	J1_44	J1_12				21	COM2	J2_44	J2_12	12	J1_12	J1_44	J3_2	J2_44	J2_12
20	COM1	J1_45	J1_13				20	COM2	J2_45	J2_13	13	J1_13	J1_45	J3_3	J2_45	J2_13
19	COM1	J1_46	J1_14				19	COM2	J2_46	J2_14	14	J1_14	J1_46	J3_4	J2_46	J2_14
18	COM1	J1_47	J1_15				18	COM2	J2_47	J2_15	15	J1_15	J1_47	J3_5	J2_47	J2_15
17	COM1	J1_48	J1_16				17	COM2	J2_48	J2_16	16	J1_16	J1_48	J3_6	J2_48	J2_16
16	COM1	J1_49	J1_17				16	COM2	J2_49	J2_17	17	J1_17	J1_49	J3_7	J2_49	J2_17
15	COM1	J1_50	J1_18				15	COM2	J2_50	J2_18	18	J1_18	J1_50	J3_8	J2_50	J2_18
14	COM1	J1_51	J1_19				14	COM2	J2_51	J2_19	19	J1_19	J1_51	J3_9	J2_51	J2_19
13	COM1	J1_52	J1_20				13	COM2	J2_52	J2_20	20	J1_20	J1_52	J3_10	J2_52	J2_20
12	COM1	J1_53	J1_21				12	COM2	J2_53	J2_21	21	J1_21	J1_53	J3_11	J2_53	J2_21
11	COM1	J1_54	J1_22				11	COM2	J2_54	J2_22	22	J1_22	J1_54	J3_12	J2_54	J2_22
10	COM1	J1_55	J1_23				10	COM2	J2_55	J2_23	23	J1_23	J1_55	COM2	J2_55	J2_23
9	COM1	J1_56	J1_24				9	COM2	J2_56	J2_24	24	J1_24	J1_56	COM2	J2_56	J2_24
8	COM1	J1_57	J1_25				8	COM2	J2_57	J2_25	25	J1_25	J1_57	COM2	J2_57	J2_25
7	COM1	J1_58	J1_26				7	COM2	J2_58	J2_26	26	J1_26	J1_58	COM2	J2_58	J2_26
6	COM1	J1_59	J1_27				6	COM2	J2_59	J2_27	27	J1_27	J1_59	COM2	J2_59	J2_27
5	COM1	J1_60	J1_28				5	COM2	J2_60	J2_28	28	J1_28	J1_60	COM2	J2_60	J2_28
4	COM1	J1_61	J1_29				4	COM2	J2_61	J2_29	29	J1_29	J1_61	COM2	J2_61	J2_29
3	COM1	J1_62	J1_30				3	COM2	J2_62	J2_30	30	J1_30	J1_62	COM2	J2_62	J2_30
2	COM1	J1_63	J1_31				2	COM2	J2_63	J2_31	31	J1_31	J1_63	COM2	J2_63	J2_31
1	COM1	J1_64	J1_32				1	COM2	J2_64	J2_32	32	J1_32	J1_64	COM2	J2_64	J2_32

U8989-66602 Breakout IO Card

Similar to the “U8989-66601 Universal Instrument Routing Card”, the U8989-66602 breakout IO card extends connectivity from the instrument interface to the DUT interface, but it is designed for the communication ports: the Serial port, LAN port, and USB ports.

The communication ports on this card are one 9 pin D-sub connector, one RJ23 ports, and two USB ports. The USB port on the instrument interface is Type B, while the USB port on DUT interface is Type A. Connector P2 is connected to the SLU backplane^[1].

Figure 3-5 U8989-66602 Breakout IO Card

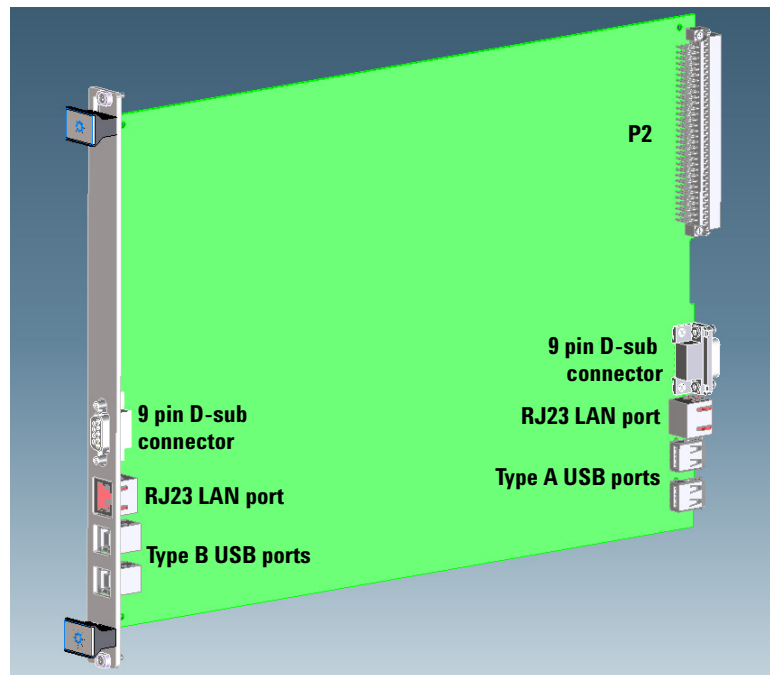

[1] There is no connectivity between the P2 connector to the SLU backplane. The connector serves as a guide and secures the breakout IO card on the SLU rail.

Instrumentation (PXI/PCI) Subsystem

Install the PXI modules according to the priority listed below.

1 M9183A 6½ Digits PXI Digital Multimeter

The M9183A DMM takes up one slot in the PXI chassis. Its functionality includes measurement of DC voltage and current, AC voltage and current, 2- and 4-wire resistance, frequency, period, capacitance, and temperature measurement.

The M9183A has a maximum measurement rate of 15000 readings/second.

2 M9185A PXI 8/16-Channel Isolated D/A Converter

The M9185A is a 2- or 3-slot fully independent, isolated D/A converter that is capable of supplying high voltage levels in parallel of up to eight or sixteen channels. Each channel is able to output up to ± 16 V as stimulus signals to DUTs.

The M9185A comes in eight or 16 channel option, where the eight-channel option is a 2-slot size module and the 16-channel option is a 3-slot size module.

3 M9187A PXI Digital IO: 32 Inputs, 32 Outputs

The M9187A has 32 input channels that can be used for comparing inputs to user-defined thresholds between 0.3 V and 50 V, with 12 mV setting resolution. Each input is protected up to 100 V. In addition, the 32 output channels use a high current to drive the output high or low, and are capable of sourcing 0.4 A from the high side or 0.5 A sink from the low side of each channel. These outputs are protected against over-voltage or over-current conditions.

The M9187A takes up one slot in the PXI chassis.

4 M9216A PXI 32-Channel High Voltage Data Acquisition (DAQ)

The M9216A only takes up two slots in the PXI chassis while offering 32 channels for high voltage data acquisition. For positive voltage measurements, the resolution is 16 bits.

The M9216A takes a large input range from 1 mV to 100 V. With this wide range of voltage input, the DAQ would have to be flexible with voltage input ranges. Thus, it has auto ranging capabilities to enable high speed parallel voltage acquisition even with a wide range of voltages. The input ranges are:

- 5 V: 1 mV to 5 V
- 100 V: 20 mV to 100 V

It has a fast sampling rate of 250 kS/s per channel.

5 M9186A PXI Isolated Single Channel Voltage/Current Source

The M9186A PXI isolated single channel voltage/current source takes up two slots in the PXI chassis.

Its high voltage range is from -10 V to 100 V and low voltage range is from -16 V to 16 V. Its high current range is from -0.2 A to 0.2 A and low current range is from -0.02 A to 0.02 A.

It also has a safety feature, which is the interlock capability. This enhances safety when using the M9186A.

PXI/PCI modules pinout

PXI M9185A DAC Pinout

NOTE

The instrument routing card must be present in your configuration.

3 System Overview

Instrumentation (PXI/PCI) Subsystem

Figure 3-6 PXI M9185A DAC Pinout (With DAC 16 Channel)

On Instrument Routing Card P2 Connector					
Row	e	d	c	b	a
1	CH1_HI	N/C	N/C	N/C	CH9_HI
2	CH1_HIS	N/C	N/C	N/C	CH9_HIS
3	CH1_LO	N/C	N/C	N/C	CH9_LO
4	CH1_LOS	N/C	N/C	N/C	CH9_LOS
5	CH2_HI	N/C	N/C	N/C	CH10_HI
6	CH2_HIS	N/C	N/C	N/C	CH10_HIS
7	CH2_LO	N/C	N/C	N/C	CH10_LO
8	CH2_LOS	N/C	N/C	N/C	CH10_LOS
9	CH3_HI	N/C	N/C	N/C	CH11_HI
10	CH3_HIS	N/C	N/C	N/C	CH11_HIS
11	CH3_LO	N/C	DMM_H	N/C	CH11_LO
12	CH3_LOS	N/C	DMM_L	N/C	CH11_LOS
13	CH4_HI	N/C	DMM_C	N/C	CH12_HI
14	CH4_HIS	N/C	CAL_GND	N/C	CH12_HIS
15	CH4_LO	N/C	GND	N/C	CH12_LO
16	CH4_LOS	N/C	EXT_TRIG_IO	N/C	CH12_LOS
17	CH5_HI	N/C	N/C	N/C	CH13_HI
18	CH5_HIS	N/C	N/C	N/C	CH13_HIS
19	CH5_LO	N/C	N/C	N/C	CH13_LO
20	CH5_LOS	N/C	N/C	N/C	CH13_LOS
21	CH6_HI	N/C	N/C	N/C	CH14_HI
22	CH6_HIS	N/C	N/C	N/C	CH14_HIS
23	CH6_LO	N/C	N/C	N/C	CH14_LO
24	CH6_LOS	N/C	N/C	N/C	CH14_LOS
25	CH7_HI	N/C	N/C	N/C	CH15_HI
26	CH7_HIS	N/C	N/C	N/C	CH15_HIS
27	CH7_LO	N/C	N/C	N/C	CH15_LO
28	CH7_LOS	N/C	N/C	N/C	CH15_LOS
29	CH8_HI	N/C	N/C	N/C	CH16_HI
30	CH8_HIS	N/C	N/C	N/C	CH16_HIS
31	CH8_LO	N/C	N/C	N/C	CH16_LO
32	CH8_LOS	N/C	N/C	N/C	CH16_LOS





Module #1

(Connect to J1, J2, and J3 column a of the Instrument Routing Card)

Figure 3-7 PXI M9185A DAC Pinout (With DAC 8 Channel)

On Instrument Routing Card P2 Connector					
Row	e	d	c	b	a
1	CH1_HI	N/C	N/C	N/C	CH1_HI
2	CH1_HIS	N/C	N/C	N/C	CH1_HIS
3	CH1_LO	N/C	N/C	N/C	CH1_LO
4	CH1_LOS	N/C	N/C	N/C	CH1_LOS
5	CH2_HI	N/C	N/C	N/C	CH2_HI
6	CH2_HIS	N/C	N/C	N/C	CH2_HIS
7	CH2_LO	N/C	N/C	N/C	CH2_LO
8	CH2_LOS	N/C	N/C	N/C	CH2_LOS
9	CH3_HI	N/C	N/C	N/C	CH3_HI
10	CH3_HIS	N/C	N/C	N/C	CH3_HIS
11	CH3_LO	N/C	DMM_H	N/C	CH3_LO
12	CH3_LOS	N/C	DMM_L	N/C	CH3_LOS
13	CH4_HI	N/C	DMM_C	N/C	CH4_HI
14	CH4_HIS	N/C	CAL_GND	N/C	CH4_HIS
15	CH4_LO	N/C	GND	N/C	CH4_LO
16	CH4_LOS	N/C	EXT_TRIG_IO	N/C	CH4_LOS
17	CH5_HI	N/C	DMM_H	N/C	CH5_HI
18	CH5_HIS	N/C	DMM_L	N/C	CH5_HIS
19	CH5_LO	N/C	DMM_C	N/C	CH5_LO
20	CH5_LOS	N/C	CAL_GND	N/C	CH5_LOS
21	CH6_HI	N/C	GND	N/C	CH6_HI
22	CH6_HIS	N/C	EXT_TRIG_IO	N/C	CH6_HIS
23	CH6_LO	N/C	N/C	N/C	CH6_LO
24	CH6_LOS	N/C	N/C	N/C	CH6_LOS
25	CH7_HI	N/C	N/C	N/C	CH7_HI
26	CH7_HIS	N/C	N/C	N/C	CH7_HIS
27	CH7_LO	N/C	N/C	N/C	CH7_LO
28	CH7_LOS	N/C	N/C	N/C	CH7_LOS
29	CH8_HI	N/C	N/C	N/C	CH8_HI
30	CH8_HIS	N/C	N/C	N/C	CH8_HIS
31	CH8_LO	N/C	N/C	N/C	CH8_LO
32	CH8_LOS	N/C	N/C	N/C	CH8_LOS

 **Module #1**
(Connect to J1 and J3
column a of the Instrument
Routing Card)

 **Module #2**
(Connect to J2 and J3
column b of the Instrument
Routing Card)

3 System Overview

Instrumentation (PXI/PCI) Subsystem

PXI M9186A VI Pinout

NOTE

The instrument routing card must be present in your configuration.

Figure 3-8 PXI M9186A VI Pinout

On Instrument Routing Card P2 Connector					
Row	e	d	c	b	a
1	N/C	N/C	N/C	N/C	N/C
2	N/C	N/C	N/C	N/C	N/C
3	N/C	N/C	N/C	N/C	N/C
4	N/C	N/C	N/C	N/C	N/C
5	N/C	N/C	N/C	N/C	N/C
6	N/C	N/C	N/C	N/C	N/C
7	N/C	N/C	N/C	N/C	N/C
8	N/C	N/C	N/C	N/C	N/C
9	N/C	N/C	N/C	N/C	N/C
10	N/C	N/C	N/C	N/C	N/C
11	N/C	N/C	N/C	N/C	N/C
12	N/C	N/C	N/C	N/C	N/C
13	N/C	N/C	INTRCLK	N/C	N/C
14	N/C	N/C	DCOM	N/C	N/C
15	N/C	N/C	N/C	N/C	N/C
16	N/C	N/C	N/C	N/C	N/C
17	N/C	N/C	N/C	N/C	N/C
18	N/C	N/C	N/C	N/C	N/C
19	N/C	N/C	INTRCLK	N/C	N/C
20	N/C	N/C	DCOM	N/C	N/C
21	N/C	N/C	N/C	N/C	N/C
22	N/C	N/C	N/C	N/C	N/C
23	N/C	N/C	N/C	N/C	N/C
24	N/C	N/C	N/C	N/C	N/C
25	N/C	N/C	N/C	N/C	N/C
26	N/C	N/C	N/C	N/C	N/C
27	N/C	N/C	N/C	N/C	N/C
28	N/C	N/C	N/C	N/C	N/C
29	N/C	N/C	N/C	N/C	N/C
30	N/C	N/C	N/C	N/C	N/C
31	N/C	N/C	N/C	N/C	N/C
32	N/C	N/C	N/C	N/C	N/C

 **Module #1**
(Connect to J3 column a of the Instrument Routing Card)

 **Module #2**
(Connect to J3 column b of the Instrument Routing Card)

PXI M9187A DIO Pinout

NOTE

The instrument routing card must be present in your configuration.

Figure 3-9 PXI M9187A DIO Pinout

On Instrument Routing Card P2 Connector					
Row	e	d	c	b	a
1	Input1	Output1	GND	Output1	Input1
2	Input2	Output2	GND	Output2	Input2
3	Input3	Output3	GND	Output3	Input3
4	Input4	Output4	GND	Output4	Input4
5	Input5	Output5	GND	Output5	Input5
6	Input6	Output6	GND	Output6	Input6
7	Input7	Output7	GND	Output7	Input7
8	Input8	Output8	GND	Output8	Input8
9	Input9	Output9	GND	Output9	Input9
10	Input10	Output10	GND	Output10	Input10
11	Input11	Output11	GND	Output11	Input11
12	Input12	Output12	Vext	Output12	Input12
13	Input13	Output13	Vext	Output13	Input13
14	Input14	Output14	Vext	Output14	Input14
15	Input15	Output15	Vext	Output15	Input15
16	Input16	Output16	GND	Output16	Input16
17	Input17	Output17	GND	Output17	Input17
18	Input18	Output18	Vext	Output18	Input18
19	Input19	Output19	Vext	Output19	Input19
20	Input20	Output20	Vext	Output20	Input20
21	Input21	Output21	Vext	Output21	Input21
22	Input22	Output22	GND	Output22	Input22
23	Input23	Output23	GND	Output23	Input23
24	Input24	Output24	GND	Output24	Input24
25	Input25	Output25	GND	Output25	Input25
26	Input26	Output26	GND	Output26	Input26
27	Input27	Output27	GND	Output27	Input27
28	Input28	Output28	GND	Output28	Input28
29	Input29	Output29	GND	Output29	Input29
30	Input30	Output30	GND	Output30	Input30
31	Input31	Output31	GND	Output31	Input31
32	Input32	Output32	GND	Output32	Input32

Module #1
(Connect to J1 and J3
column a of the Instrument
Routing Card)

Module #2
(Connect to J2 and J3
column b of the Instrument
Routing Card)

3 System Overview

Instrumentation (PXI/PCI) Subsystem

PXI M9216A DAQ Input Port Pinout

NOTE

- The instrument routing card must be present in your configuration.
- COM is equivalent to the DAQ.G pin.

Figure 3-10 PXI M9216A DAQ Input Port Pinout

On Instrument Routing Card P2 Connector					
Row	e	d	c	b	a
1	Port1	N/C	COM	N/C	Port1
2	Port9	N/C	COM	N/C	Port9
3	Port17	N/C	COM	N/C	Port17
4	Port25	N/C	COM	N/C	Port25
5	Port2	N/C	COM	N/C	Port2
6	Port10	N/C	COM	N/C	Port10
7	Port18	N/C	COM	N/C	Port18
8	Port26	N/C	COM	N/C	Port26
9	Port3	N/C	COM	N/C	Port3
10	Port11	N/C	COM	N/C	Port11
11	Port19	N/C	N/C	N/C	Port19
12	Port27	N/C	N/C	N/C	Port27
13	Port4	N/C	N/C	N/C	Port4
14	Port12	N/C	N/C	N/C	Port12
15	Port20	N/C	N/C	N/C	Port20
16	Port28	N/C	N/C	N/C	Port28
17	Port5	N/C	N/C	N/C	Port5
18	Port13	N/C	N/C	N/C	Port13
19	Port21	N/C	N/C	N/C	Port21
20	Port29	N/C	N/C	N/C	Port29
21	Port6	N/C	N/C	N/C	Port6
22	Port14	N/C	N/C	N/C	Port14
23	Port22	N/C	COM	N/C	Port22
24	Port30	N/C	COM	N/C	Port30
25	Port7	N/C	COM	N/C	Port7
26	Port15	N/C	COM	N/C	Port15
27	Port23	N/C	COM	N/C	Port23
28	Port31	N/C	COM	N/C	Port31
29	Port8	N/C	COM	N/C	Port8
30	Port16	N/C	COM	N/C	Port16
31	Port24	N/C	COM	N/C	Port24
32	Port32	N/C	COM	N/C	Port32

Module #1
(Connect to J1 of the Instrument Routing Card)

Module #2
(Connect to J3 of the Instrument Routing Card)

PXI M9216A DAQ Aux Port Pinout

NOTE

The E879xA pin matrix card must be present in your configuration.

Figure 3-11 PXI M9216A DAQ Aux Port Pinout (E879xA)

On E879xA Pin Matrix Card Aux P2 Connector					
Row	c		b		a
	Pin	Pin Reference	Pin	Pin Reference	Pin
1	UUT COM	DAQ2.AC0M	Aux1	DAQ2.Aux82	Row1
2	UUT COM	DAQ2.AC0M	Aux2	DAQ2.Aux81	Row2
3	UUT COM	DAQ2.AC0M	Aux3	DAQ2.Aux72	Row3
4	UUT COM	DAQ2.AC0M	Aux4	DAQ2.Aux71	Row4
5	UUT COM	DAQ2.AC0M	Aux5	DAQ2.Aux62	Row5
6	UUT COM	DAQ2.AC0M	Aux6	DAQ2.Aux61	Row6
7	UUT COM	DAQ2.AC0M	Aux7	DAQ2.Aux52	Row7
8	UUT COM	DAQ2.AC0M	Aux8	DAQ2.Aux51	Row8
9	UUT COM	DAQ2.AC0M	Aux9	DAQ2.Aux42	Row9
10	UUT COM	DAQ2.AC0M	Aux10	DAQ2.Aux41	Row10
11	UUT COM	DAQ2.AC0M	Aux11	DAQ2.Aux32	Row11
12	UUT COM	DAQ2.AC0M	Aux12	DAQ2.Aux31	Row12
13	UUT COM	DAQ2.AC0M	Aux13	DAQ2.Aux22	Row13
14	UUT COM	DAQ2.AC0M	Aux14	DAQ2.Aux21	Row14
15	UUT COM	DAQ2.AC0M	Aux15	DAQ2.Aux12	Row15
16	UUT COM	DAQ2.AC0M	Aux16	DAQ2.Aux11	Row16
17	UUT COM	DAQ1.AC0M	Aux17	DAQ1.Aux82	Row17
18	UUT COM	DAQ1.AC0M	Aux18	DAQ1.Aux81	Row18
19	UUT COM	DAQ1.AC0M	Aux19	DAQ1.Aux72	Row19
20	UUT COM	DAQ1.AC0M	Aux20	DAQ1.Aux71	Row20
21	UUT COM	DAQ1.AC0M	Aux21	DAQ1.Aux62	Row21
22	UUT COM	DAQ1.AC0M	Aux22	DAQ1.Aux61	Row22
23	UUT COM	DAQ1.AC0M	Aux23	DAQ1.Aux52	Row23
24	UUT COM	DAQ1.AC0M	Aux24	DAQ1.Aux51	Row24
25	UUT COM	DAQ1.AC0M	Aux25	DAQ1.Aux42	Row25
26	UUT COM	DAQ1.AC0M	Aux26	DAQ1.Aux41	Row26
27	UUT COM	DAQ1.AC0M	Aux27	DAQ1.Aux32	Row27
28	UUT COM	DAQ1.AC0M	Aux28	DAQ1.Aux31	Row28
29	UUT COM	DAQ1.AC0M	Aux29	DAQ1.Aux22	Row29
30	UUT COM	DAQ1.AC0M	Aux30	DAQ1.Aux21	Row30
31	UUT COM	DAQ1.AC0M	Aux31	DAQ1.Aux12	Row31
32	UUT COM	DAQ1.AC0M	Aux32	DAQ1.Aux11	Row32

NOTE

The E878xA pin matrix card must be present in your configuration.

Figure 3-12 PXI M9216A DAQ Aux Port Pinout (E878xA)

On E878xA Pin Matrix Card Aux P2 Connector								
Row	e	d	c		b		a	
	Pin	Pin	Pin	Pin Reference	Pin	Pin Reference	Pin	Pin Reference
1	Row1	Row33	Aux1	DAQ1.Aux11	Aux33	DAQ1.Aux21	UUT COM	DAQ1.ACOM
2	Row2	Row34	Aux2	DAQ1.Aux12	Aux34	DAQ1.Aux22	UUT COM	DAQ1.ACOM
3	Row3	Row35	Aux3	DAQ1.Aux31	Aux35	DAQ1.Aux41	UUT COM	DAQ1.ACOM
4	Row4	Row36	Aux4	DAQ1.Aux42	Aux36	DAQ1.Aux42	UUT COM	DAQ1.ACOM
5	Row5	Row37	Aux5	DAQ1.Aux51	Aux37	DAQ1.Aux61	UUT COM	DAQ1.ACOM
6	Row6	Row38	Aux6	DAQ1.Aux52	Aux38	DAQ1.Aux62	UUT COM	DAQ1.ACOM
7	Row7	Row39	Aux7	DAQ1.Aux71	Aux39	DAQ1.Aux81	UUT COM	DAQ1.ACOM
8	Row8	Row40	Aux8	DAQ1.Aux72	Aux40	DAQ1.Aux82	UUT COM	DAQ1.ACOM
9	Row9	Row41	Aux9	DAQ2.Aux11	Aux41	DAQ2.Aux21	UUT COM	DAQ2.ACOM
10	Row10	Row42	Aux10	DAQ2.Aux12	Aux42	DAQ2.Aux22	UUT COM	DAQ2.ACOM
11	Row11	Row43	Aux11	DAQ2.Aux31	Aux43	DAQ2.Aux41	UUT COM	DAQ2.ACOM
12	Row12	Row44	Aux12	DAQ2.Aux42	Aux44	DAQ2.Aux42	UUT COM	DAQ2.ACOM
13	Row13	Row45	Aux13	DAQ2.Aux51	Aux45	DAQ2.Aux61	UUT COM	DAQ2.ACOM
14	Row14	Row46	Aux14	DAQ2.Aux52	Aux46	DAQ2.Aux62	UUT COM	DAQ2.ACOM
15	Row15	Row47	Aux15	DAQ2.Aux71	Aux47	DAQ2.Aux81	UUT COM	DAQ2.ACOM
16	Row16	Row48	Aux16	DAQ2.Aux72	Aux48	DAQ2.Aux82	UUT COM	DAQ2.ACOM
17	Row17	Row49	Aux17	DAQ3.Aux11	Aux49	DAQ3.Aux21	UUT COM	DAQ3.ACOM
18	Row18	Row50	Aux18	DAQ3.Aux12	Aux50	DAQ3.Aux22	UUT COM	DAQ3.ACOM
19	Row19	Row51	Aux19	DAQ3.Aux31	Aux51	DAQ3.Aux41	UUT COM	DAQ3.ACOM
20	Row20	Row52	Aux20	DAQ3.Aux42	Aux52	DAQ3.Aux42	UUT COM	DAQ3.ACOM
21	Row21	Row53	Aux21	DAQ3.Aux51	Aux53	DAQ3.Aux61	UUT COM	DAQ3.ACOM
22	Row22	Row54	Aux22	DAQ3.Aux52	Aux54	DAQ3.Aux62	UUT COM	DAQ3.ACOM
23	Row23	Row55	Aux23	DAQ3.Aux71	Aux55	DAQ3.Aux81	UUT COM	DAQ3.ACOM
24	Row24	Row56	Aux24	DAQ3.Aux72	Aux56	DAQ3.Aux82	UUT COM	DAQ3.ACOM
25	Row25	Row57	Aux25	DAQ4.Aux11	Aux57	DAQ4.Aux21	UUT COM	DAQ4.ACOM
26	Row26	Row58	Aux26	DAQ4.Aux12	Aux58	DAQ4.Aux22	UUT COM	DAQ4.ACOM
27	Row27	Row59	Aux27	DAQ4.Aux31	Aux59	DAQ4.Aux41	UUT COM	DAQ4.ACOM
28	Row28	Row60	Aux28	DAQ4.Aux42	Aux60	DAQ4.Aux42	UUT COM	DAQ4.ACOM
29	Row29	Row61	Aux29	DAQ4.Aux51	Aux61	DAQ4.Aux61	UUT COM	DAQ4.ACOM
30	Row30	Row62	Aux30	DAQ4.Aux52	Aux62	DAQ4.Aux62	UUT COM	DAQ4.ACOM
31	Row31	Row63	Aux31	DAQ4.Aux71	Aux63	DAQ4.Aux81	UUT COM	DAQ4.ACOM
32	Row32	Row64	Aux32	DAQ4.Aux72	Aux64	DAQ4.Aux82	UUT COM	DAQ4.ACOM

PCI AD1750 DIO Pinout

NOTE

The instrument routing card must be present in your configuration.

Figure 3-13 PCI AD1750 DIO Pinout

On Instrument Routing Card P2 Connector					
Row	e	d	c	b	a
1	DI0	N/C	GND	N/C	DI0
2	DI1	N/C	GND	N/C	DI1
3	DI2	N/C	GND	N/C	DI2
4	DI3	N/C	GND	N/C	DI3
5	DI4	N/C	GND	N/C	DI4
6	DI5	N/C	GND	N/C	DI5
7	DI6	N/C	GND	N/C	DI6
8	DI7	N/C	GND	N/C	DI7
9	DI8	N/C	GND	N/C	DI8
10	DI9	N/C	GND	N/C	DI9
11	DI10	N/C	N/C	N/C	DI10
12	DI11	N/C	N/C	N/C	DI11
13	DI12	N/C	N/C	N/C	DI12
14	DI13	N/C	N/C	N/C	DI13
15	DI14	N/C	N/C	N/C	DI14
16	DI15	N/C	N/C	N/C	DI15
17	DO0	COM1	N/C	COM1	DO0
18	DO1	COM1	N/C	COM1	DO1
19	DO2	COM1	N/C	COM1	DO2
20	DO3	COM1	N/C	COM1	DO3
21	DO4	COM1	N/C	COM1	DO4
22	DO5	COM1	N/C	COM1	DO5
23	DO6	COM1	GND	COM1	DO6
24	DO7	COM1	GND	COM1	DO7
25	DO8	COM2	GND	COM2	DO8
26	DO9	COM2	GND	COM2	DO9
27	DO10	COM2	GND	COM2	DO10
28	DO11	COM2	GND	COM2	DO11
29	DO12	COM2	GND	COM2	DO12
30	DO13	COM2	GND	COM2	DO13
31	DO14	COM2	GND	COM2	DO14
32	DO15	COM2	GND	COM2	DO15

Module #1
(Connect to J1 of the Instrument Routing Card)

Module #2
(Connect to J2 of the Instrument Routing Card)

3 System Overview

Instrumentation (PXI/PCI) Subsystem

PCI Softing CAN Pinout

NOTE

The instrument routing card must be present in your configuration.

Figure 3-14 PCI Softing CAN Pinout

On Instrument Routing Card P2 Connector					
Row	e	d	c	b	a
1	N/C	N/C	N/C	N/C	N/C
2	N/C	N/C	N/C	N/C	N/C
3	N/C	N/C	N/C	N/C	N/C
4	N/C	N/C	N/C	N/C	N/C
5	N/C	N/C	N/C	N/C	N/C
6	N/C	N/C	N/C	N/C	N/C
7	N/C	N/C	N/C	N/C	N/C
8	N/C	N/C	N/C	N/C	N/C
9	N/C	N/C	N/C	N/C	N/C
10	N/C	N/C	N/C	N/C	N/C
11	N/C	N/C	CH1.CAN_H	N/C	N/C
12	N/C	N/C	CH1.CAN_L	N/C	N/C
13	N/C	N/C	CH1.GND	N/C	N/C
14	N/C	N/C	CH2.GND	N/C	N/C
15	N/C	N/C	CH2.CAN_L	N/C	N/C
16	N/C	N/C	CH2.CAN_H	N/C	N/C
17	N/C	N/C	CH1.CAN_H	N/C	N/C
18	N/C	N/C	CH1.CAN_L	N/C	N/C
19	N/C	N/C	CH1.GND	N/C	N/C
20	N/C	N/C	CH2.GND	N/C	N/C
21	N/C	N/C	CH2.CAN_L	N/C	N/C
22	N/C	N/C	CH2.CAN_H	N/C	N/C
23	N/C	N/C	N/C	N/C	N/C
24	N/C	N/C	N/C	N/C	N/C
25	N/C	N/C	N/C	N/C	N/C
26	N/C	N/C	N/C	N/C	N/C
27	N/C	N/C	N/C	N/C	N/C
28	N/C	N/C	N/C	N/C	N/C
29	N/C	N/C	N/C	N/C	N/C
30	N/C	N/C	N/C	N/C	N/C
31	N/C	N/C	N/C	N/C	N/C
32	N/C	N/C	N/C	N/C	N/C

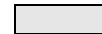

Module #1

(Connect to J3 column a of the Instrument Routing Card)



Module #2

(Connect to J3 column b of the Instrument Routing Card)

Switch/Load Unit (SLU) Subsystem

The Agilent E6198B switch/load unit acts as a switching platform for the TS-8989 system. The E6198B utilizes a standard VERSA Module Eurocard (VME) type enclosure to bring you the best-in-class switching solution for mechatronic type testing.

The E6198B is controlled via USB. It has four power busses which can take loads up to 30 A each.

The E6198B comes with added features that provide you with an 8-bit DIO that can be used for fixture control or ID, a pair of DAC channels to drive voltage controlled power supplies.

For more detailed information on the specifications and usage of this unit, refer to the *E6198B User's Guide*.

Switch/Load Unit pinout

E8792A/E8793A 32-pin Matrix Card Pinout

Figure 3-15 E8792A/E8793A 32-pin Matrix Card Pinout

E8792A/E8793A			
P2 Connector on E8792A/93A Pin Card			
Row	c	b	a
1	UUT Com	Aux1	Row1
2	UUT Com	Aux2	Row2
3	UUT Com	Aux3	Row3
4	UUT Com	Aux4	Row4
5	UUT Com	Aux5	Row5
6	UUT Com	Aux6	Row6
7	UUT Com	Aux7	Row7
8	UUT Com	Aux8	Row8
9	UUT Com	Aux9	Row9
10	UUT Com	Aux10	Row10
11	UUT Com	Aux11	Row11
12	UUT Com	Aux12	Row12
13	UUT Com	Aux13	Row13
14	UUT Com	Aux14	Row14
15	UUT Com	Aux15	Row15
16	UUT Com	Aux16	Row16
17	UUT Com	Aux17	Row17
18	UUT Com	Aux18	Row18
19	UUT Com	Aux19	Row19
20	UUT Com	Aux20	Row20
21	UUT Com	Aux21	Row21
22	UUT Com	Aux22	Row22
23	UUT Com	Aux23	Row23
24	UUT Com	Aux24	Row24
25	UUT Com	Aux25	Row25
26	UUT Com	Aux26	Row26
27	UUT Com	Aux27	Row27
28	UUT Com	Aux28	Row28
29	UUT Com	Aux29	Row29
30	UUT Com	Aux30	Row30
31	UUT Com	Aux31	Row31
32	UUT Com	Aux32	Row32

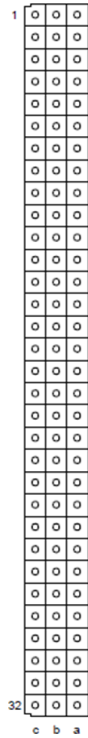

E8782A/E8783A 64-pin Matrix Card Pinout

Figure 3-16 E8782A/E8783A 64-pin Matrix Card Pinout

		E8782A						E8783A					
		P2 Connector on E8782A Pin Card						P2 Connector on E8783A Pin Card					
		Row	e	d	c	b	a	Row	e	d	c	b	a
1		1	Row1	Row33	Aux1	Aux33	UUT Com	1	Row1	Row33	Aux1	Aux33	UUT Com
		2	Row2	Row34	Aux2	Aux34	UUT Com	2	Row2	Row34	Aux2	Aux34	UUT Com
		3	Row3	Row35	Aux3	Aux35	UUT Com	3	Row3	Row35	Aux3	Aux35	UUT Com
		4	Row4	Row36	Aux4	Aux36	UUT Com	4	Row4	Row36	Aux4	Aux36	UUT Com
		5	Row5	Row37	Aux5	Aux37	UUT Com	5	Row5	Row37	Aux5	Aux37	UUT Com
		6	Row6	Row38	Aux6	Aux38	UUT Com	6	Row6	Row38	Aux6	Aux38	UUT Com
		7	Row7	Row39	Aux7	Aux39	UUT Com	7	Row7	Row39	Aux7	Aux39	UUT Com
		8	Row8	Row40	Aux8	Aux40	UUT Com	8	Row8	Row40	Aux8	Aux40	UUT Com
		9	Row9	NC	Aux9	NC	UUT Com	9	Row9	Row41	Aux9	Aux41	UUT Com
		10	Row10	NC	Aux10	NC	UUT Com	10	Row10	Row42	Aux10	Aux42	UUT Com
		11	Row11	NC	Aux11	NC	UUT Com	11	Row11	Row43	Aux11	Aux43	UUT Com
		12	Row12	NC	Aux12	NC	UUT Com	12	Row12	Row44	Aux12	Aux44	UUT Com
		13	Row13	NC	Aux13	NC	UUT Com	13	Row13	Row45	Aux13	Aux45	UUT Com
		14	Row14	NC	Aux14	NC	UUT Com	14	Row14	Row46	Aux14	Aux46	UUT Com
		15	Row15	NC	Aux15	NC	UUT Com	15	Row15	Row47	Aux15	Aux47	UUT Com
		16	Row16	NC	Aux16	NC	UUT Com	16	Row16	Row48	Aux16	Aux48	UUT Com
		17	Row17	NC	Aux17	NC	UUT Com	17	Row17	Row49	Aux17	Aux49	UUT Com
		18	Row18	NC	Aux18	NC	UUT Com	18	Row18	Row50	Aux18	Aux50	UUT Com
		19	Row19	NC	Aux19	NC	UUT Com	19	Row19	Row51	Aux19	Aux51	UUT Com
		20	Row20	NC	Aux20	NC	UUT Com	20	Row20	Row52	Aux20	Aux52	UUT Com
		21	Row21	NC	Aux21	NC	UUT Com	21	Row21	Row53	Aux21	Aux53	UUT Com
		22	Row22	NC	Aux22	NC	UUT Com	22	Row22	Row54	Aux22	Aux54	UUT Com
		23	Row23	NC	Aux23	NC	UUT Com	23	Row23	Row55	Aux23	Aux55	UUT Com
		24	Row24	NC	Aux24	NC	UUT Com	24	Row24	Row56	Aux24	Aux56	UUT Com
		25	Row25	NC	Aux25	NC	UUT Com	25	Row25	Row57	Aux25	Aux57	UUT Com
		26	Row26	NC	Aux26	NC	UUT Com	26	Row26	Row58	Aux26	Aux58	UUT Com
		27	Row27	NC	Aux27	NC	UUT Com	27	Row27	Row59	Aux27	Aux59	UUT Com
		28	Row28	NC	Aux28	NC	UUT Com	28	Row28	Row60	Aux28	Aux60	UUT Com
		29	Row29	NC	Aux29	NC	UUT Com	29	Row29	Row61	Aux29	Aux61	UUT Com
		30	Row30	NC	Aux30	NC	UUT Com	30	Row30	Row62	Aux30	Aux62	UUT Com
		31	Row31	NC	Aux31	NC	UUT Com	31	Row31	Row63	Aux31	Aux63	UUT Com
		32	Row32	NC	Aux32	NC	UUT Com	32	Row32	Row64	Aux32	Aux64	UUT Com

3 System Overview

Switch/Load Unit (SLU) Subsystem

78-pin SLU System Utility Pinout

Figure 3-17 78-pin SLU System Utility Pinout

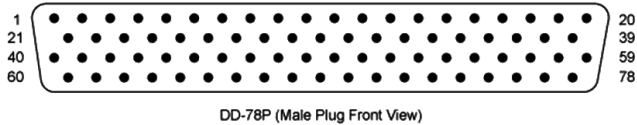

SLU System Utility							
78-pin D-Sub Connector Pinouts							
Pin	Pin Reference	Pin	Pin Reference	Pin	Pin Reference	Pin	Pin Reference
1	System Gnd	21	System Gnd	40	System Gnd	60	System Gnd
2	Fixture ID (0)	22	Open Drain Out (0)	41	Digital In (0)	61	Spare_DigOut(0)
3	Fixture ID (1)	23	Open Drain Out (1)	42	Digital In (1)	62	Spare_DigOut(1)
4	Fixture ID (2)	24	Open Drain Out (2)	43	Digital In (2)	63	Spare_DigOut(2)
5	Fixture ID (3)	25	Open Drain Out (3)	44	Digital In (3)	64	Spare_DigOut(3)
6	Fixture ID (4)	26	Open Drain Out (4)	45	Digital In (4)	65	Spare_DigOut(4)
7	Fixture ID (5)	27	Open Drain Out (5)	46	Digital In (5)	66	Spare_DigOut(5)
8	Fixture ID (6)	28	Open Drain Out (6)	47	Digital In (6)	67	Spare_DigOut(6)
9	Fixture ID (7)	29	Open Drain Out (7)	48	Digital In (7)	68	Spare_DigOut(7)
10	System Gnd	30	System Gnd	49	System Gnd	69	System Gnd
11	ISense+ (1)	31	ISense- (1)	50	Power Bus Sense 1	70	+12 Vdc Supply
12	ISense+ (2)	32	ISense- (2)	51	Power Bus Sense 2	71	+12 Vdc Supply
13	ISense+ (3)	33	ISense- (3)	52	Power Bus Sense 3	72	+12 Vdc Supply
14	ISense+ (4)	34	ISense- (4)	53	Power Bus Sense 4	73	+12 Vdc Supply
15	NC	35	NC	54	NC	74	-12 Vdc Supply
16	DAC1	36	DAC2	55	NC	75	Spare Supply
17	System Gnd	37	System Gnd	56	NC	76	NC
18	NC	38	NC	57	NC	77	NC
19	NC	39	NC	58	NC	78	NC
20	NC		NC	59	NC		NC

N9379A 48 Channel Load Card Pinout

Figure 3-18 N9379A 48 Channel Load Card Pinout

N9379A			
P2 Connector on Load Card			
Row	c	b	a
1	Ch3	Ch2	Ch1
2	CH3 Pow	CH2 Pow	CH1 Pow
3	CH6	CH5	CH4
4	CH6 Pow	CH5 Pow	CH4 Pow
5	CH9	CH8	CH7
6	CH9 Pow	CH8 Pow	CH7 Pow
7	CH12	CH11	CH10
8	CH12 Pow	CH11 Pow	CH10 Pow
9	CH15	CH14	CH13
10	CH15 Pow	CH14 Pow	CH13 Pow
11	CH18	CH17	CH16
12	CH18 Pow	CH17 Pow	CH16 Pow
13	CH21	CH20	CH19
14	CH21 Pow	CH20 Pow	CH19 Pow
15	CH24	CH23	CH22
16	CH24 Pow	CH23 Pow	CH22 Pow
17	CH27	CH26	CH25
18	CH27 Pow	CH26 Pow	CH25 Pow
19	CH30	CH29	CH28
20	CH30 Pow	CH29 Pow	CH28 Pow
21	CH33	CH32	CH31
22	CH33 Pow	CH32 Pow	CH31 Pow
23	CH36	CH35	CH34
24	CH36 Pow	CH35 Pow	CH34 Pow
25	CH39	CH38	CH37
26	CH39 Pow	CH38 Pow	CH37 Pow
27	CH42	CH41	CH40
28	CH42 Pow	CH41 Pow	CH40 Pow
29	CH45	CH44	CH43
30	CH45 Pow	CH44 Pow	CH43 Pow
31	CH48	CH47	CH46
32	CH48 Pow	CH47 Pow	CH46 Pow

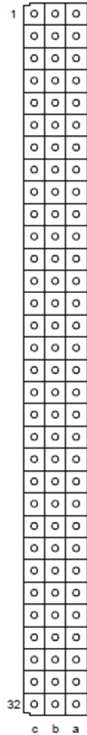

E6176A/N9377A/U7179A 16 Channel Load Card Pinout

Figure 3-19 E6176A/N9377A/U7179A 16 Channel Load Card Pinout

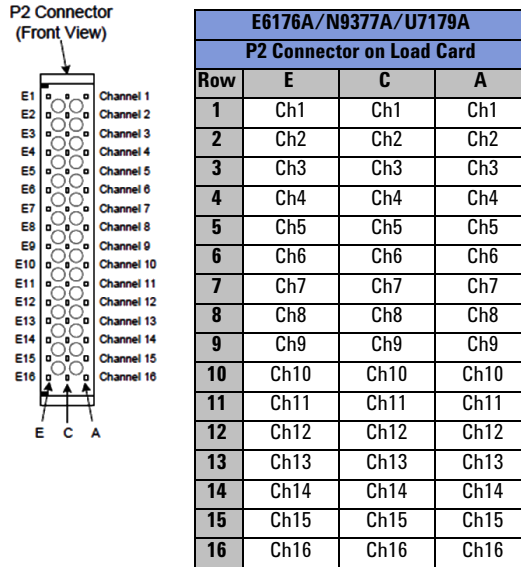

E6177A/U7177A/N9378A 24 Channel Load Card Pinout

Figure 3-20 E6177A/U7177A/N9378A 24 Channel Load Card Pinout

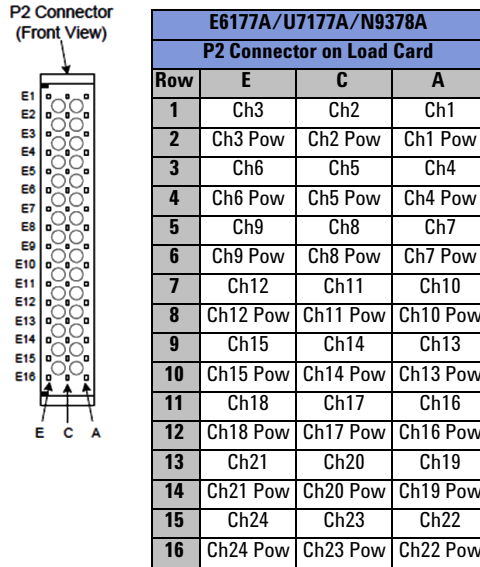

E6175A 8 Channel Load Card Pinout

Figure 3-21 E6175A 8 Channel Load Card Pinout

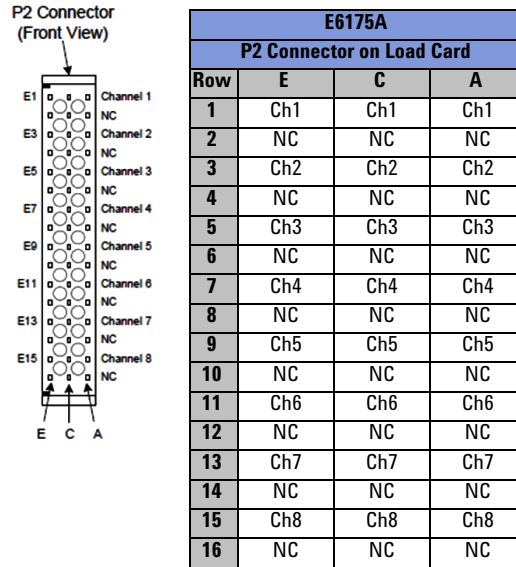

E6178B/U7178A 8 Channel Heavy Duty Load Card Pinout

Figure 3-22 E6178B/U7178A 8 Channel Heavy Duty Load Card Pinout

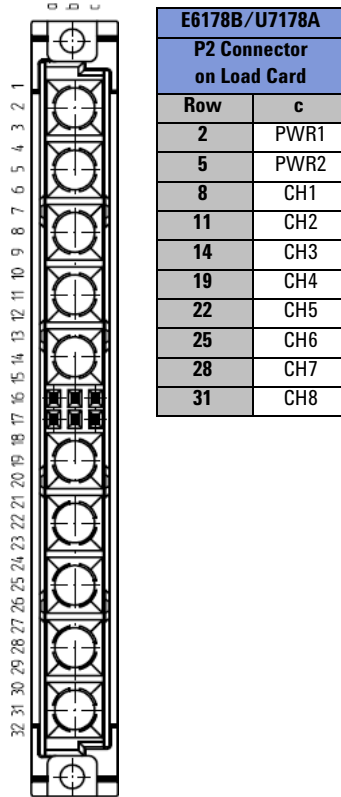

3 System Overview

Switch/Load Unit (SLU) Subsystem

THIS PAGE HAS BEEN INTENTIONALLY LEFT BLANK.



4 System Interconnects

System Interface 52

Mounting Plate Installation 54



System Interface

There is no mass system interface for the TS-8989 system. You are required to connect the DUT fixture cables directly onto the load card or pin card. [Table 4-1](#) lists all the available modules and connector types.

Table 4-1 Available modules and connector types

Connectors	Mating connector ^[1]	Mating Pin	Use in
78-pin D-Sub Connector	1658674-1 (AMP)	1658670-1 (AMP)	SLU Utility
96-pos DIN Connector	925486-1 (AMP)	1-104480-3 (AMP)	E879xA Matrix Card 48-Ch Load Card
48-pos DIN Connector	9050483202 (HARTING)	9060006472 (Harting)	24-/16-/8-Ch Load Card
160-pos DIN Connector	24070 (ERNI)	234063 (ERNI)	E878xA Matrix Card Universal Instrument Routing Card
10-pos Heavy Duty Connector	354152 (ERNI)	594172 (ERNI)	Heavy Duty Load Card

[1] The mating connectors listed in this column are the suggested mating connectors.

Agilent also offers the E6170-02100 mounting plate ([Figure 4-1](#) on page 53) to secure the connector on the TS-8989 system.

Figure 4-1 E6170-02100 Mounting Plate

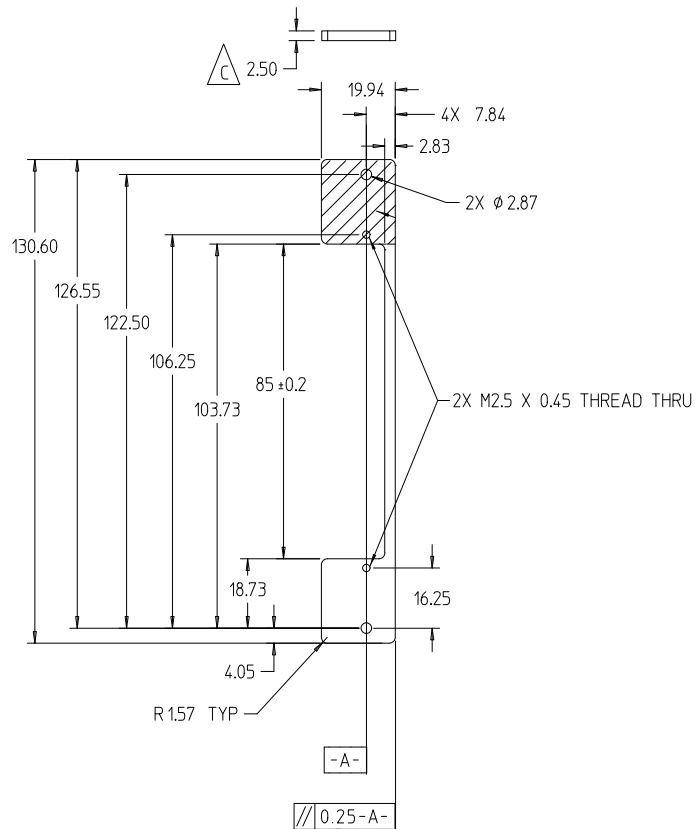

Mounting Plate Installation

- 1 Install one piece of the E6170-02100 and two pieces of 0515-0894 onto the fixture cable that connects to the pin card or load card or instrument routing card.

Figure 4-2 Mounting Plate Installation Step 1



- 2 Remove the cards from the SLU.

Figure 4-3 Mounting Plate Installation Step 2



WARNING

Turn OFF the power supply before you remove the cards.

- 3 Next, proceed to install the fixture cable with the 0515-0894 pre-installed onto the T-threaded strip at the back of the SLU and fasten it with two pieces of the 0515-0894 at the top and bottom of the T-threaded strips accordingly.

Figure 4-4 Mounting Plate Installation Step 3

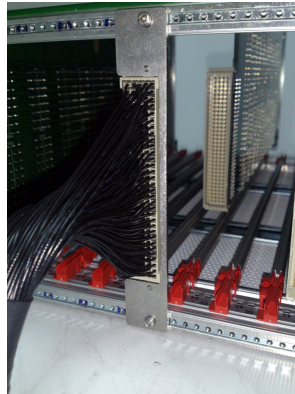

- 4 Upon completion, proceed to insert the pin matrix card or load card or instrument routing card into the respective SLU slot, mating it with the fixture cable installed at the T-threaded strip.

Figure 4-5 Mounting Plate Installation Step 4

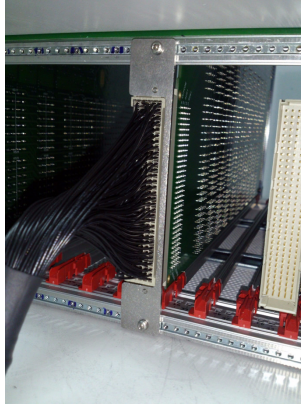

5 For the TS-8989 that is integrated into a rack, Agilent recommends that a strain relief bar be installed – to fasten the fixture cables – to eliminate possible intermittent disconnection between the fixture cables and its respective pin matrix or load card or instrument routing card. Below is a sample of a strain relief bar that is installed in Agilent's functional test systems.

Figure 4-6 Mounting Plate Installation Step 5

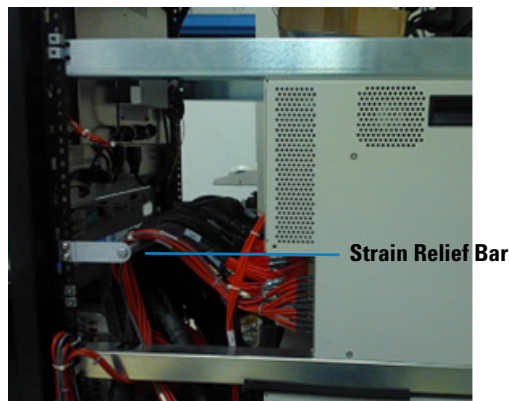



5 Test System Interface Cables

- U8989-61606 DAC M9185A to Instrument Routing Card or E8792A Pin Matrix Aux Cable [58](#)
- U8989-61609 DIO M9187A to Instrument Routing Card Cable [60](#)
- U8989-61607 DAQ M9216A to Instrument Routing Card Cable [62](#)
- U8989-61608 DAQ M9216A Aux to E8792A Pin Matrix Aux Cable [64](#)
- U8970-61705 DAQ M9216A Aux to E8782A Pin Matrix Aux Cable [66](#)
- U8989-61611 VI M9186A to Instrument Routing Card and Pin Matrix Instrument Cable [69](#)
- U8989-61610 PCI DIO AD1750 Cable [71](#)
- U8989-61612 PCI Softing CAN (CAN-AC2-PCI) Cable [73](#)

This chapter shows the construction and pinouts of the system cables that connect to the test system interface.



5 Test System Interface Cables

U8989-61606 DAC M9185A to Instrument Routing Card or E8792A Pin Matrix Aux Cable

U8989-61606 DAC M9185A to Instrument Routing Card or E8792A Pin Matrix Aux Cable

Figure 5-1 U8989-61606 DAC M9185A to Instrument Routing Card or E8792A Pin Matrix Aux Cable

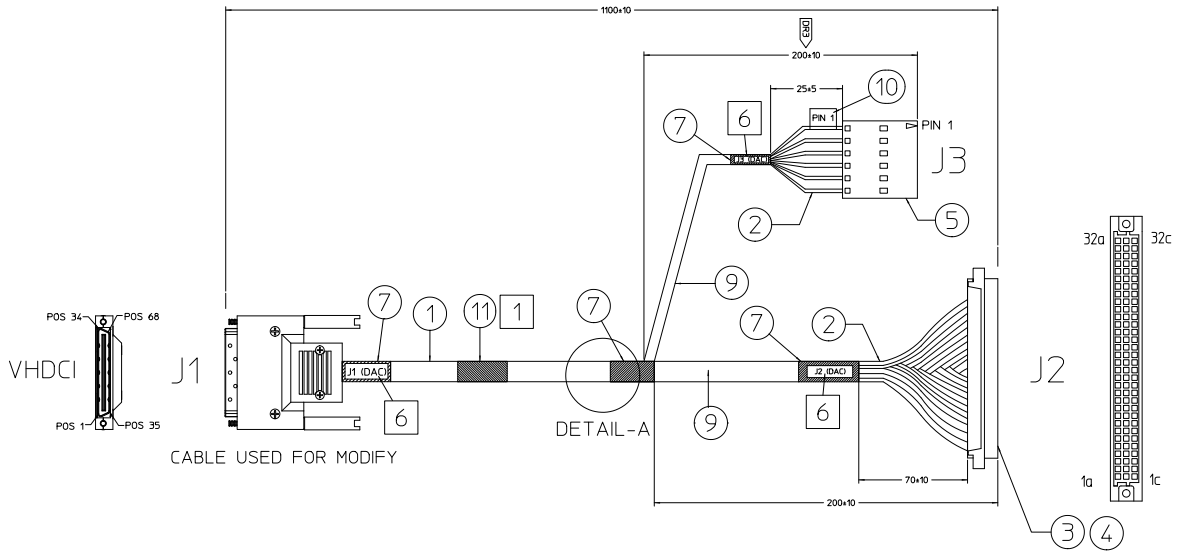

Table 5-1 U8989-61606 Cable Pinout

J1				J2				J3		
To DAC Channel 1-8 ^{[1][2]}				To Inst Routing Connector J1 or J2				To Inst Routing Connector J3 ^[1]		
Pin	Pinout	Pin	Pinout	Pin	a	b	c	Pin	Pinout	Remark
1	CH1_LO	35	CH1_HI	32	N/C	N/C	CH1_HI	6	DMM_H	
2	CH1_LOS	36	CH1_HIS	31	N/C	N/C	CH1_HIS	5	DMM_L	
3	GND	37	GND	30	N/C	N/C	CH1_LO	4	DMM_C	
4	CH2_LO	38	CH2_HI	29	N/C	N/C	CH1_LOS	3	CAL_GND	From J1 Pin 63
5	CH2_LOS	39	CH2_HIS	28	N/C	N/C	CH2_HI	2	GND	From J1 Pin 66
6	GND	40	GND	27	N/C	N/C	CH2_HIS	1	EXT_TRIG_IO	
7	CH3_LO	41	CH3_HI	26	N/C	N/C	CH2_LO			
8	CH3_LOS	42	CH3_HIS	25	N/C	N/C	CH2_LOS			
9	GND	43	GND	24	N/C	N/C	CH3_HI			
10	CH4_LO	44	CH4_HI	23	N/C	N/C	CH3_HIS			
11	CH4_LOS	45	CH4_HIS	22	N/C	N/C	CH3_LO			
12	GND	46	GND	21	N/C	N/C	CH3_LOS			
13	CH5_LO	47	CH5_HI	20	N/C	N/C	CH4_HI			
14	CH5_LOS	48	CH5_HIS	19	N/C	N/C	CH4_HIS			
15	GND	49	GND	18	N/C	N/C	CH4_LO			
16	CH6_LO	50	CH6_HI	17	N/C	N/C	CH4_LOS			
17	CH6_LOS	51	CH6_HIS	16	N/C	N/C	CH5_HI			
18	GND	52	GND	15	N/C	N/C	CH5_HIS			
19	CH7_LO	53	CH7_HI	14	N/C	N/C	CH5_LO			
20	CH7_LOS	54	CH7_HIS	13	N/C	N/C	CH5_LOS			
21	GND	55	GND	12	N/C	N/C	CH6_HI			
22	CH8_LO	56	CH8_HI	11	N/C	N/C	CH6_HIS			
23	CH8_LOS	57	CH8_HIS	10	N/C	N/C	CH6_LO			
24	GND	58	GND	9	N/C	N/C	CH6_LOS			
25	GND	59	GND	8	N/C	N/C	CH7_HI			
26	CAL_GND	60	CAL_GND	7	N/C	N/C	CH7_HIS			
27	CAL_GND	61	CAL_GND	6	N/C	N/C	CH7_LO			
28	DMM_H	62	DMM_L	5	N/C	N/C	CH7_LOS			
29	DMM_C	63	CAL_GND	4	N/C	N/C	CH8_HI			
30	CAL_GND	64	CAL_GND	3	N/C	N/C	CH8_HIS			
31	CAL_GND	65	CAL_GND	2	N/C	N/C	CH8_LO			
32	GND	66	GND	1	N/C	N/C	CH8_LOS			
33	EXT_TRIG_IO	67	GND							
34	GND	68	GND							

[1] If J1 is connect to DAC Channel 9-16, J3 will not connect to the Instrument Routing Card

[1] The same cable can be used for DAC Channel 9-16

[2] Pin 26-34 and Pin 60-68 will be GND for DAC Channel 9-16

5 Test System Interface Cables

U8989-61609 DIO M9187A to Instrument Routing Card Cable

U8989-61609 DIO M9187A to Instrument Routing Card Cable

Figure 5-2 U8989-61609 DIO M9187A to Instrument Routing Card Cable

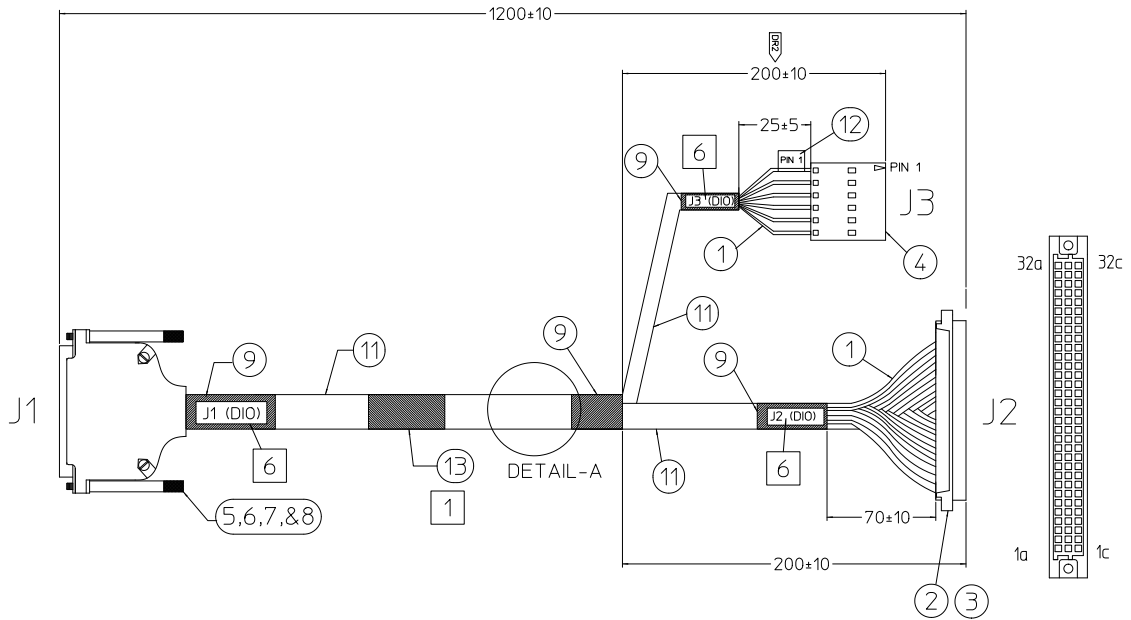

Table 5-2 U8989-61609 Cable Pinout

J1							
To DIO							
Pin	Pinout	Pin	Pinout	Pin	Pinout	Pin	Pinout
60	Vext	40	Vext	21	Vext	1	Vext
61	Output 4	41	Output 3	22	Output 2	2	Output 1
62	Output 8	42	Output 7	23	Output 6	3	Output 5
63	Output 12	43	Output 11	24	Output 10	4	Output 9
64	Output 16	44	Output 15	25	Output 14	5	Output 13
65	Output 20	45	Output 19	26	Output 18	6	Output 17
66	Output 24	46	Output 23	27	Output 22	7	Output 21
67	Output 28	47	Output 27	28	Output 26	8	Output 25
68	Output 32	48	Output 31	29	Output 30	9	Output 29
69	GND	49	GND	30	GND	10	GND
70	Input 4	50	Input 3	31	Input 2	11	Input 1
71	Input 8	51	Input 7	32	Input 6	12	Input 5
72	Input 12	52	Input 11	33	Input 10	13	Input 9
73	Input 16	53	Input 15	34	Input 14	14	Input 13
74	Input 20	54	Input 19	35	Input 18	15	Input 17
75	Input 24	55	Input 23	36	Input 22	16	Input 21
76	Input 28	56	Input 27	37	Input 26	17	Input 25
77	Input 32	57	Input 31	38	Input 30	18	Input 29
78	GND	58	GND	39	GND	19	GND
		59	GND			20	GND

J2			
To Inst Routing Connector J1 or J2			
Pin	a	b	c
32	GND	Output1	Input1
31	GND	Output2	Input2
30	GND	Output3	Input3
29	GND	Output4	Input4
28	GND	Output5	Input5
27	GND	Output6	Input6
26	GND	Output7	Input7
25	GND	Output8	Input8
24	N/C	Output9	Input9
23	N/C	Output10	Input10
22	N/C	Output11	Input11
21	N/C	Output12	Input12
20	N/C	Output13	Input13
19	N/C	Output14	Input14
18	N/C	Output15	Input15
17	N/C	Output16	Input16
16	N/C	Output17	Input17
15	N/C	Output18	Input18
14	N/C	Output19	Input19
13	N/C	Output20	Input20
12	N/C	Output21	Input21
11	N/C	Output22	Input22
10	N/C	Output23	Input23
9	N/C	Output24	Input24
8	N/C	Output25	Input25
7	N/C	Output26	Input26
6	N/C	Output27	Input27
5	N/C	Output28	Input28
4	N/C	Output29	Input29
3	N/C	Output30	Input30
2	N/C	Output31	Input31
1	N/C	Output32	Input32

J3	
To Inst Routing Connector J3	
Pin	Pinout
6	GND
5	Vext
4	Vext
3	Vext
2	Vext
1	GND

5 Test System Interface Cables

U8989-61607 DAQ M9216A to Instrument Routing Card Cable

U8989-61607 DAQ M9216A to Instrument Routing Card Cable

Figure 5-3 U8989-61607 DAQ M9216A to Instrument Routing Card Cable

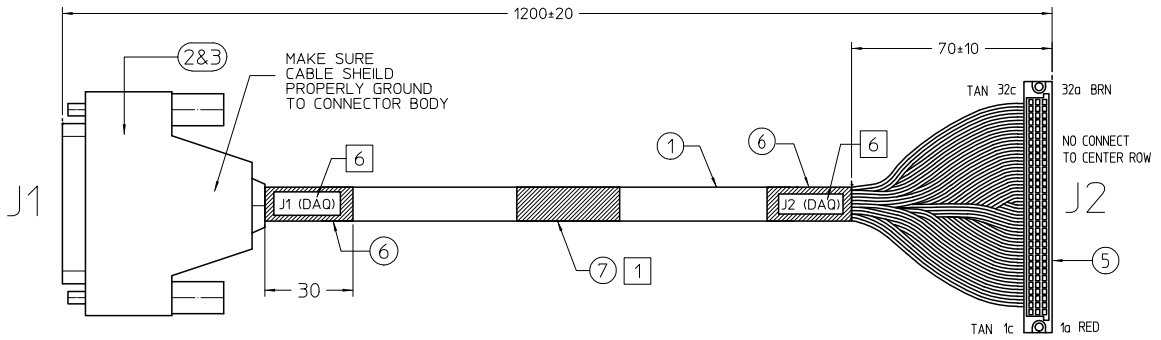

Table 5-3 U8989-61607 Cable Pinout

J1					
To DAQ Input Port					
Pin	Pinout	Pin	Pinout	Pin	Pinout
44	Port24	30	G4	15	Port16
43	Port32	29	G4	14	Port8
42	Port23	28	G4	13	Port15
41	Port31	27	G4	12	Port7
40	Port22	26	G3	11	Port14
39	Port21	25	Port30	10	Port6
38	Port29	24	G3	9	Port13
37	Port20	23	G3	8	Port5
36	Port28	22	G2	7	Port12
35	Port19	21	Port11	6	Port4
34	Port27	20	G2	5	Port3
33	Port18	19	G1	4	Port10
32	Port26	18	G1	3	Port2
31	Port25	17	G1	2	Port9
		16	Port17	1	Port1

J2			
To Inst Routing Connector J1 or J2			
Pin	a	b	c
32	G1	N/C	Port1
31	G1	N/C	Port9
30	G1	N/C	Port17
29	G1	N/C	Port25
28	G1	N/C	Port2
27	G1	N/C	Port10
26	G1	N/C	Port18
25	G1	N/C	Port26
24	G2	N/C	Port3
23	G2	N/C	Port11
22	G2	N/C	Port19
21	G2	N/C	Port27
20	G2	N/C	Port4
19	G2	N/C	Port12
18	G2	N/C	Port20
17	G2	N/C	Port28
16	G3	N/C	Port5
15	G3	N/C	Port13
14	G3	N/C	Port21
13	G3	N/C	Port29
12	G3	N/C	Port6
11	G3	N/C	Port14
10	G3	N/C	Port22
9	G3	N/C	Port30
8	G4	N/C	Port7
7	G4	N/C	Port15
6	G4	N/C	Port23
5	G4	N/C	Port31
4	G4	N/C	Port8
3	G4	N/C	Port16
2	G4	N/C	Port24
1	G4	N/C	Port32

5 Test System Interface Cables

U8989-61608 DAQ M9216A Aux to E8792A Pin Matrix Aux Cable

U8989-61608 DAQ M9216A Aux to E8792A Pin Matrix Aux Cable

Figure 5-4 U8989-61608 DAQ M9216A Aux to E8792A Pin Matrix Aux Cable [1]

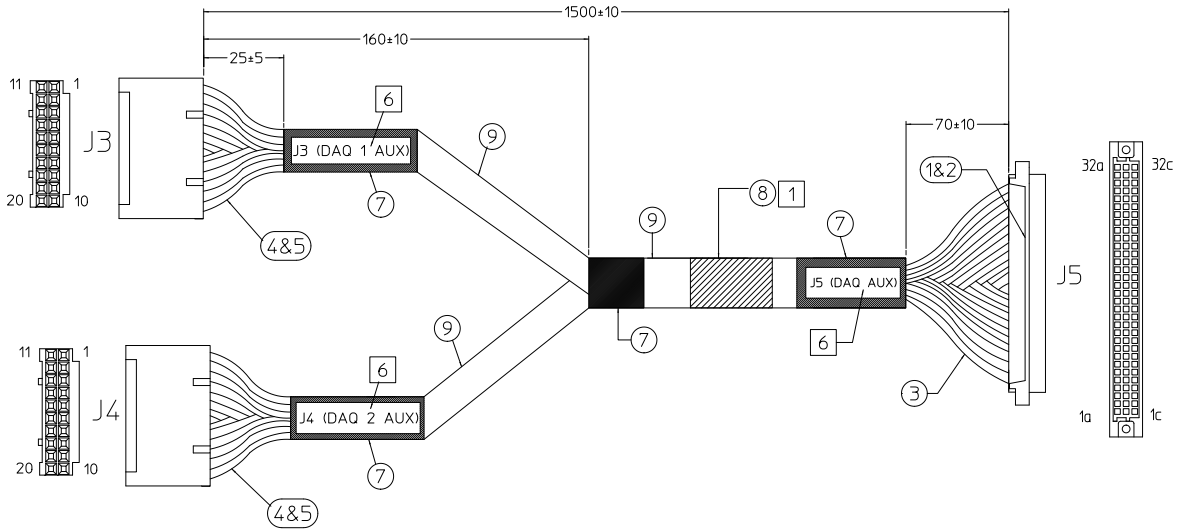

[1] This cable can connect up to two DAQ modules.

Table 5-4 U8989-61608 Cable Pinout

J3			
To DAQ Aux Port (DAQ1)			
Pin	Pinout	Pin	Pinout
20	DAQ1.Aux82	10	DAQ1.Aux72
19	DAQ1.Aux81	9	DAQ1.Aux71
18	DAQ1.ACom4	8	DAQ1.ACom3
17	DAQ1.Aux62	7	DAQ1.Aux52
16	DAQ1.Aux61	6	DAQ1.Aux51
15	DAQ1.Aux42	5	DAQ1.Aux32
14	DAQ1.Aux41	4	DAQ1.Aux31
13	DAQ1.ACom2	3	DAQ1.ACom1
12	DAQ1.Aux22	2	DAQ1.Aux12
11	DAQ1.Aux21	1	DAQ1.Aux11

J4			
To DAQ Aux Port (DAQ2)			
Pin	Pinout	Pin	Pinout
11	DAQ2.Aux82	10	DAQ2.Aux72
12	DAQ2.Aux81	9	DAQ2.Aux71
13	DAQ2.ACom4	8	DAQ2.ACom3
14	DAQ2.Aux62	7	DAQ2.Aux52
15	DAQ2.Aux61	6	DAQ2.Aux51
16	DAQ2.Aux42	5	DAQ2.Aux32
17	DAQ2.Aux41	4	DAQ2.Aux31
18	DAQ2.ACom2	3	DAQ2.ACom1
19	DAQ2.Aux22	2	DAQ2.Aux12
20	DAQ2.Aux21	1	DAQ2.Aux11

J5			
To E879xA Aux			
Pin	a	b	c
32	DAQ1.ACOM1	N/C	DAQ1.AUX11
31	N/C	N/C	DAQ1.AUX12
30	N/C	N/C	DAQ1.AUX21
29	N/C	N/C	DAQ1.AUX22
28	DAQ1.ACOM2	N/C	DAQ1.AUX31
27	N/C	N/C	DAQ1.AUX32
26	N/C	N/C	DAQ1.AUX41
25	N/C	N/C	DAQ1.AUX42
24	DAQ1.ACOM3	N/C	DAQ1.AUX51
23	N/C	N/C	DAQ1.AUX52
22	N/C	N/C	DAQ1.AUX61
21	N/C	N/C	DAQ1.AUX62
20	DAQ1.ACOM4	N/C	DAQ1.AUX71
19	N/C	N/C	DAQ1.AUX72
18	N/C	N/C	DAQ1.AUX81
17	N/C	N/C	DAQ1.AUX82
16	DAQ2.ACOM1	N/C	DAQ2.AUX11
15	N/C	N/C	DAQ2.AUX12
14	N/C	N/C	DAQ2.AUX21
13	N/C	N/C	DAQ2.AUX22
12	DAQ2.ACOM2	N/C	DAQ2.AUX31
11	N/C	N/C	DAQ2.AUX32
10	N/C	N/C	DAQ2.AUX41
9	N/C	N/C	DAQ2.AUX42
8	DAQ2.ACOM3	N/C	DAQ2.AUX51
7	N/C	N/C	DAQ2.AUX52
6	N/C	N/C	DAQ2.AUX61
5	N/C	N/C	DAQ2.AUX62
4	DAQ2.ACOM4	N/C	DAQ2.AUX71
3	N/C	N/C	DAQ2.AUX72
2	N/C	N/C	DAQ2.AUX81
1	N/C	N/C	DAQ2.AUX82

5 Test System Interface Cables

U8970-61705 DAQ M9216A Aux to E8782A Pin Matrix Aux Cable

U8970-61705 DAQ M9216A Aux to E8782A Pin Matrix Aux Cable

Figure 5-5 U8970-61705 DAQ M9216A Aux to E8782A Pin Matrix Aux Cable^[1]

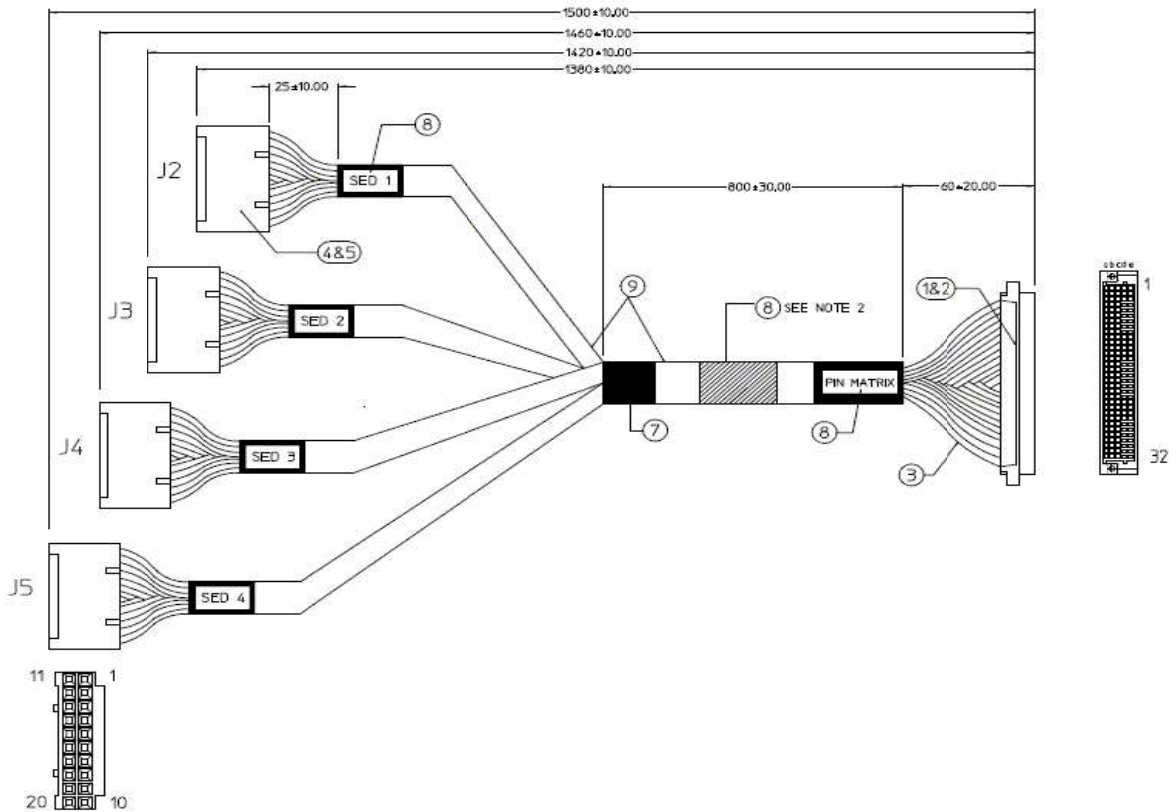

[1] This cable can connect up to four DAQ modules.

Table 5-5 U8970-61705 Cable Pinout

J2			
To DAQ Aux Port (DAQ1)			
Pin	Pinout	Pin	Pinout
20	DAQ1.Aux82	10	DAQ1.Aux72
19	DAQ1.Aux81	9	DAQ1.Aux71
18	DAQ1.ACom4	8	DAQ1.ACom3
17	DAQ1.Aux62	7	DAQ1.Aux52
16	DAQ1.Aux61	6	DAQ1.Aux51
15	DAQ1.Aux42	5	DAQ1.Aux32
14	DAQ1.Aux41	4	DAQ1.Aux31
13	DAQ1.ACom2	3	DAQ1.ACom1
12	DAQ1.Aux22	2	DAQ1.Aux12
11	DAQ1.Aux21	1	DAQ1.Aux11

J3			
To DAQ Aux Port (DAQ2)			
Pin	Pinout	Pin	Pinout
20	DAQ2.Aux82	10	DAQ2.Aux72
19	DAQ2.Aux81	9	DAQ2.Aux71
18	DAQ2.ACom4	8	DAQ2.ACom3
17	DAQ2.Aux62	7	DAQ2.Aux52
16	DAQ2.Aux61	6	DAQ2.Aux51
15	DAQ2.Aux42	5	DAQ2.Aux32
14	DAQ2.Aux41	4	DAQ2.Aux31
13	DAQ2.ACom2	3	DAQ2.ACom1
12	DAQ2.Aux22	2	DAQ2.Aux12
11	DAQ2.Aux21	1	DAQ2.Aux11

J4			
To DAQ Aux Port (DAQ3)			
Pin	Pinout	Pin	Pinout
20	DAQ3.Aux82	10	DAQ3.Aux72
19	DAQ3.Aux81	9	DAQ3.Aux71
18	DAQ3.ACom4	8	DAQ3.ACom3
17	DAQ3.Aux62	7	DAQ3.Aux52
16	DAQ3.Aux61	6	DAQ3.Aux51
15	DAQ3.Aux42	5	DAQ3.Aux32
14	DAQ3.Aux41	4	DAQ3.Aux31
13	DAQ3.ACom2	3	DAQ3.ACom1
12	DAQ3.Aux22	2	DAQ3.Aux12
11	DAQ3.Aux21	1	DAQ3.Aux11

J5			
To DAQ Aux Port (DAQ4)			
Pin	Pinout	Pin	Pinout
20	DAQ4.Aux82	10	DAQ4.Aux72
19	DAQ4.Aux81	9	DAQ4.Aux71
18	DAQ4.ACom4	8	DAQ4.ACom3
17	DAQ4.Aux62	7	DAQ4.Aux52
16	DAQ4.Aux61	6	DAQ4.Aux51
15	DAQ4.Aux42	5	DAQ4.Aux32
14	DAQ4.Aux41	4	DAQ4.Aux31
13	DAQ4.ACom2	3	DAQ4.ACom1
12	DAQ4.Aux22	2	DAQ4.Aux12
11	DAQ4.Aux21	1	DAQ4.Aux11

5 Test System Interface Cables

U8970-61705 DAQ M9216A Aux to E8782A Pin Matrix Aux Cable

Table 5-6 U8970-61705 Cable Pinout

J1					
To E878xA Aux					
Pin	a	b	c	d	e
32	DAQ1.AUX11	DAQ1.ACOM1	N/C	DAQ1.ACOM1	DAQ1.AUX21
31	DAQ1.AUX12	DAQ1.ACOM1	N/C	DAQ1.ACOM1	DAQ1.AUX22
30	DAQ1.AUX31	DAQ1.ACOM2	N/C	DAQ1.ACOM2	DAQ1.AUX41
29	DAQ1.AUX32	DAQ1.ACOM2	N/C	DAQ1.ACOM2	DAQ1.AUX42
28	DAQ1.AUX51	DAQ1.ACOM3	N/C	DAQ1.ACOM3	DAQ1.AUX61
27	DAQ1.AUX52	DAQ1.ACOM3	N/C	DAQ1.ACOM3	DAQ1.AUX62
26	DAQ1.AUX71	DAQ1.ACOM4	N/C	DAQ1.ACOM4	DAQ1.AUX81
25	DAQ1.AUX72	DAQ1.ACOM4	N/C	DAQ1.ACOM4	DAQ1.AUX82
24	DAQ2.AUX11	DAQ2.ACOM1	N/C	DAQ2.ACOM1	DAQ2.AUX21
23	DAQ2.AUX12	DAQ2.ACOM1	N/C	DAQ2.ACOM1	DAQ2.AUX22
22	DAQ2.AUX31	DAQ2.ACOM2	N/C	DAQ2.ACOM2	DAQ2.AUX41
21	DAQ2.AUX32	DAQ2.ACOM2	N/C	DAQ2.ACOM2	DAQ2.AUX42
20	DAQ2.AUX51	DAQ2.ACOM3	N/C	DAQ2.ACOM3	DAQ2.AUX61
19	DAQ2.AUX52	DAQ2.ACOM3	N/C	DAQ2.ACOM3	DAQ2.AUX62
18	DAQ2.AUX71	DAQ2.ACOM4	N/C	DAQ2.ACOM4	DAQ2.AUX81
17	DAQ2.AUX72	DAQ2.ACOM4	N/C	DAQ2.ACOM4	DAQ2.AUX82
16	DAQ3.AUX11	DAQ3.ACOM1	N/C	DAQ3.ACOM1	DAQ3.AUX21
15	DAQ3.AUX12	DAQ3.ACOM1	N/C	DAQ3.ACOM1	DAQ3.AUX22
14	DAQ3.AUX31	DAQ3.ACOM2	N/C	DAQ3.ACOM2	DAQ3.AUX41
13	DAQ3.AUX32	DAQ3.ACOM2	N/C	DAQ3.ACOM2	DAQ3.AUX42
12	DAQ3.AUX51	DAQ3.ACOM3	N/C	DAQ3.ACOM3	DAQ3.AUX61
11	DAQ3.AUX52	DAQ3.ACOM3	N/C	DAQ3.ACOM3	DAQ3.AUX62
10	DAQ3.AUX71	DAQ3.ACOM4	N/C	DAQ3.ACOM4	DAQ3.AUX81
9	DAQ3.AUX72	DAQ3.ACOM4	N/C	DAQ3.ACOM4	DAQ3.AUX82
8	DAQ4.AUX11	DAQ4.ACOM1	N/C	DAQ4.ACOM1	DAQ4.AUX21
7	DAQ4.AUX12	DAQ4.ACOM1	N/C	DAQ4.ACOM1	DAQ4.AUX22
6	DAQ4.AUX31	DAQ4.ACOM2	N/C	DAQ4.ACOM2	DAQ4.AUX41
5	DAQ4.AUX32	DAQ4.ACOM2	N/C	DAQ4.ACOM2	DAQ4.AUX42
4	DAQ4.AUX51	DAQ4.ACOM3	N/C	DAQ4.ACOM3	DAQ4.AUX61
3	DAQ4.AUX52	DAQ4.ACOM3	N/C	DAQ4.ACOM3	DAQ4.AUX62
2	DAQ4.AUX71	DAQ4.ACOM4	N/C	DAQ4.ACOM4	DAQ4.AUX81
1	DAQ4.AUX72	DAQ4.ACOM4	N/C	DAQ4.ACOM4	DAQ4.AUX82

5 Test System Interface Cables

U8989-61611 VI M9186A to Instrument Routing Card and Pin Matrix Instrument Cable

Table 5-7 U8989-61611 Cable Pinout

J1			
To VI			
Pin	Pinout	Pinout	Pin
1	DCOM	INTRLCK	4
2	GND	GND	5
3	OUTPUT	SENSE	6

J2		
To Instrument Matrix		
Pin	Pinout	Remark
A	GND	From J1 Pin 2
B	OUTPUT	From J1 Pin 3
C	N/C	

J3		
To Instrument Matrix		
Pin	Pinout	Remark
D	GND	From J1 Pin 5
E	SENSE	From J1 Pin 6
F	N/C	

J4		
To Inst Routing Connector J3		
Pin	Pinout	Remark
6	N/C	
5	N/C	
4	INTRLCK	From J1 Pin 4
3	DCOM	From J1 Pin 1
2	N/C	
1	N/C	

U8989-61610 PCI DIO AD1750 Cable

Figure 5-7 U8989-61610 PCI DIO AD1750 Cable

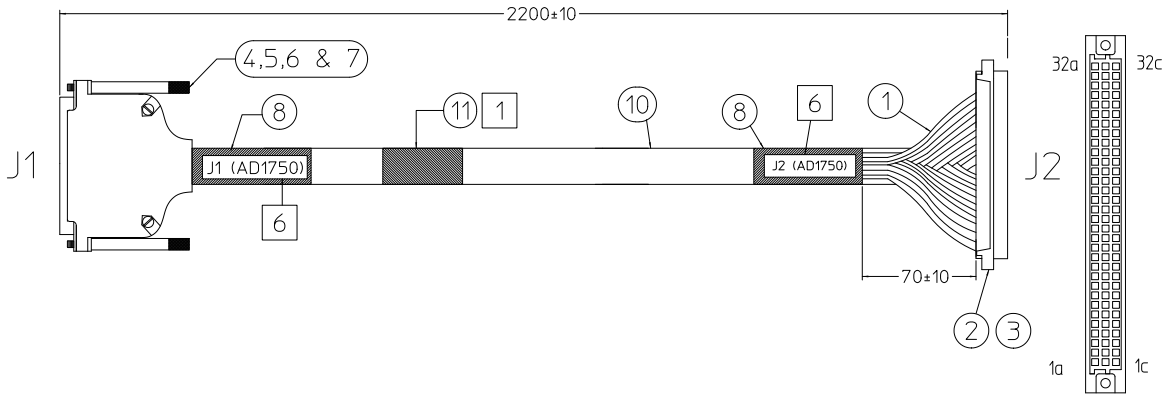

5 Test System Interface Cables

U8989-61610 PCI DIO AD1750 Cable

Table 5-8 U8989-61610 Cable Pinout

J1				J2			
To DIO				To Inst Routing Connector J1 or J2			
Pin	Pinout	Pin	Pinout	Pin	a	b	c
1	DI0	20	DI1	32	GND	N/C	DI0
2	DI2	21	DI3	31	GND	N/C	DI1
3	DI4	22	DI5	30	GND	N/C	DI2
4	DI6	23	DI7	29	N/C	N/C	DI3
5	DI8	24	DI9	28	N/C	N/C	DI4
6	DI10	25	DI11	27	N/C	N/C	DI5
7	DI12	26	DI13	26	N/C	N/C	DI6
8	DI14	27	DI15	25	N/C	N/C	DI7
9	GND	28	GND	24	N/C	N/C	DI8
10	COM1	29	GND	23	N/C	N/C	DI9
11	DO0	30	DO1	22	N/C	N/C	DI10
12	DO2	31	DO3	21	N/C	N/C	DI11
13	DO4	32	DO5	20	N/C	N/C	DI12
14	DO6	33	DO7	19	N/C	N/C	DI13
15	DO8	34	DO9	18	N/C	N/C	DI14
16	DO10	35	DO11	17	N/C	N/C	DI15
17	DO12	36	DO13	16	N/C	COM1	DO0
18	DO14	37	DO15	15	N/C	COM1	DO1
19	COM2			14	N/C	COM1	DO2
				13	N/C	COM1	DO3
				12	N/C	COM1	DO4
				11	N/C	COM1	DO5
				10	N/C	COM1	DO6
				9	N/C	COM1	DO7
				8	N/C	COM2	DO8
				7	N/C	COM2	DO9
				6	N/C	COM2	DO10
				5	N/C	COM2	DO11
				4	N/C	COM2	DO12
				3	N/C	COM2	DO13
				2	N/C	COM2	DO14
				1	N/C	COM2	DO15

U8989-61612 PCI Softing CAN (CAN-AC2-PCI) Cable

Figure 5-8 U8989-61612 PCI Softing CAN (CAN-AC2-PCI) Cable

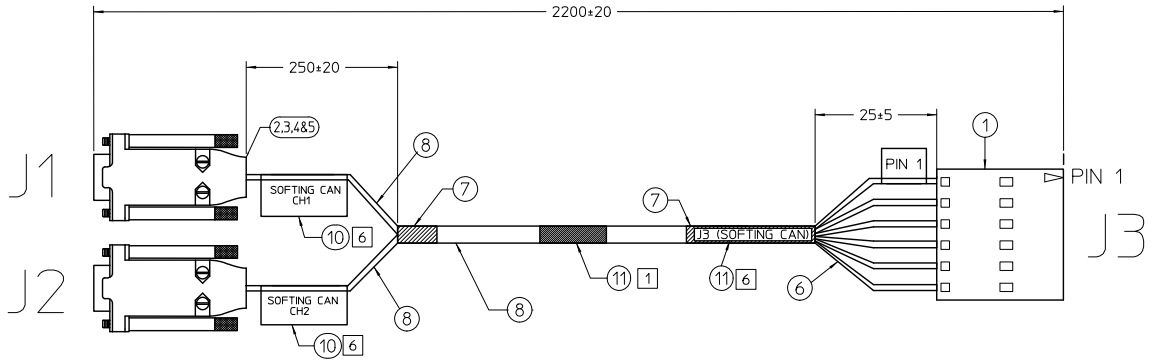

5 Test System Interface Cables

U8989-61612 PCI Softing CAN (CAN-AC2-PCI) Cable

Table 5-9 U8989-61612 Cable Pinout

J1	
To Softing CAN CH1	
Pin	Pinout
1	N/C
2	CH1.CAN_L
3	N/C
4	N/C
5	N/C
6	CH1.GND
7	CH1.CAN_H
8	N/C
9	N/C

J3		
To Inst Routing Connector J3		
Pin	Pinout	Remark
6	CH1.CAN_H	
5	CH1.CAN_L	
4	CH1.GND	From J1 Pin 6
3	CH2.GND	From J2 Pin 6
2	CH2.CAN_L	
1	CH2.CAN_H	

J2	
To Softing CAN CH2	
Pin	Pinout
1	N/C
2	CH2.CAN_L
3	N/C
4	N/C
5	N/C
6	CH2.GND
7	CH2.CAN_H
8	N/C
9	N/C

www.agilent.com

Contact us

To obtain service, warranty, or technical assistance, contact us at the following phone or fax numbers:

United States:

(tel) 800 829 4444 (fax) 800 829 4433

Canada:

(tel) 877 894 4414 (fax) 800 746 4866

China:

(tel) 800 810 0189 (fax) 800 820 2816

Europe:

(tel) 31 20 547 2111

Japan:

(tel) (81) 426 56 7832 (fax) (81) 426 56 7840

Korea:

(tel) (080) 769 0800 (fax) (080) 769 0900

Latin America:

(tel) (305) 269 7500

Taiwan:

(tel) 0800 047 866 (fax) 0800 286 331

Other Asia Pacific Countries:

(tel) (65) 6375 8100 (fax) (65) 6755 0042

Or visit Agilent World Wide Web at:

www.agilent.com/find/assist

Product specifications and descriptions in this document are subject to change without notice. Always refer to Agilent website for the latest revision.

© Agilent Technologies Inc., 2014

First Edition, January 22, 2014
U8989-90001



Agilent Technologies